



National Aeronautics and
Space Administration

Educational Product

Educators
& Students

Grades 5-12

EP-1998-12-384-HQ

NASA's Great Observatories

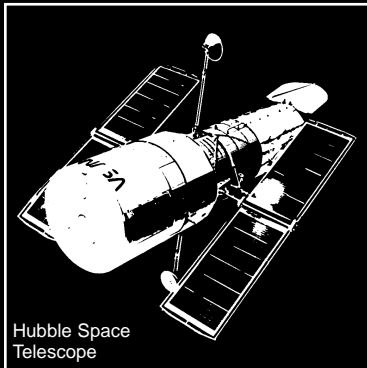

Hubble Space
Telescope



Chandra X-ray
Observatory

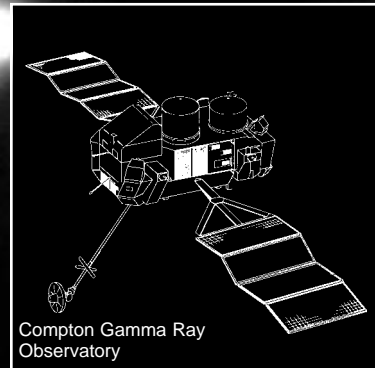

Compton Gamma Ray
Observatory

P A P E R M O D E L



NASA's Great Observatories: Paper Model is available in electronic format through NASA Spacelink—one of the Agency's electronic resources specifically developed for use by the educational community.

The system may be accessed at the following address:
<http://spacelink.nasa.gov/products>

NASA's Great Observatories

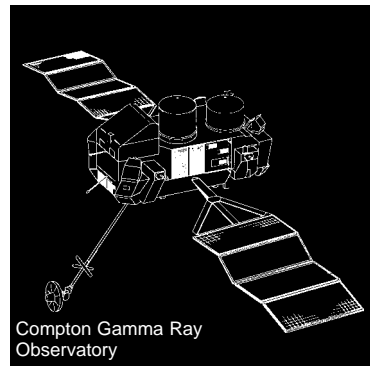
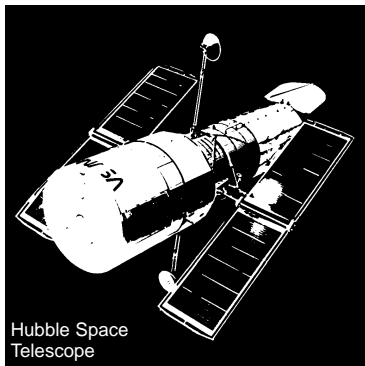

P A P E R M O D E L



National Aeronautics and
Space Administration

This publication is in the Public Domain and is not protected by copyright.
Permission is not requested for duplication.
EP-1998-12-384-HQ

NASA's Great Observatories

Why are space observatories important? The answer concerns twinkling stars in the night sky. To reach telescopes on Earth, light from distant objects has to penetrate Earth's atmosphere. Although the sky may look clear, the gases that make up our atmosphere cause problems for astronomers. These gases absorb the majority of radiation emanating from celestial bodies so that it never reaches the astronomer's telescope. Radiation that does make it to the surface is distorted by pockets of warm and cool air, causing the twinkling effect. In spite of advanced computer enhancement, the images finally seen by astronomers are incomplete.

Observatories located in space collect data free from the distortion of Earth's atmosphere. Space observatories contain advanced, highly sensitive instruments, such as telescopes (the Hubble Space Telescope and the Chandra X-ray Observatory) and detectors (the Compton Gamma Ray Observatory and Chandra X-ray Observatory), that allow scientists to study radiation from neighboring planets and galaxies billions of light years away. By analyzing the spectrum of radiation emitted or absorbed by an object, scientists can determine the temperature, chemical composition, and motion of an object. The light from these distant celestial bodies may take billions of years to reach the observatories, so scientists can actually look into the past and learn what was happening in the universe when it was young. The data that these observatories gather help scientists

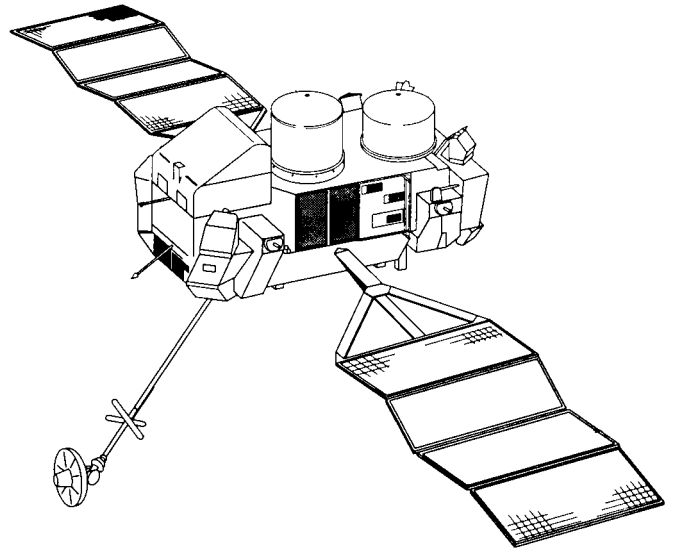

determine how stars and galaxies are formed and provide insights into the origin and evolution of the universe.

NASA, in conjunction with other countries' space agencies, commercial companies, and the international community, has built observatories such as the Hubble Space Telescope, the Compton Gamma Ray Observatory, and the Chandra X-ray Observatory to find the answers to numerous questions about the universe. With the capabilities the Space Shuttle provides, scientist now have the means for deploying these observatories from the Shuttle's cargo bay directly into orbit.

Who Are They Named for?

Each of the three spacecraft represented by models here are named for noted astronomers in the fields of optical and high-energy astronomy. The Hubble Space Telescope is named for Edwin Hubble. The Compton Gamma Ray Observatory is named for Arthur Holly Compton, and the Chandra X-ray Observatory is named for Subrahmanyan Chandrasekhar. "Chandra" was a nickname used by Chandrasekhar. Assign some students the task of researching these three astronomers and their accomplishments.

For more information about the NASA Great Observatories, visit the Office of Space Science web site at <http://spacescience.nasa.gov/missions/index.htm>

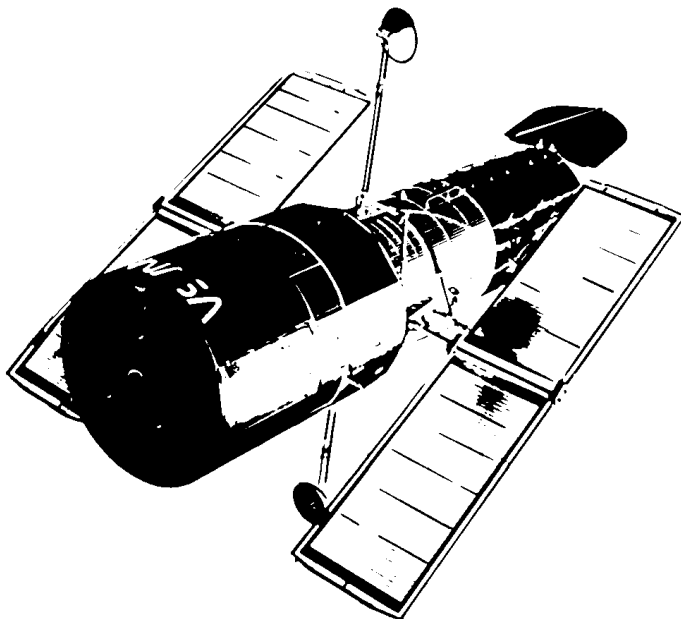

Hubble Space Telescope

NASA's Hubble Space Telescope, the first of the great observatories, was deployed from the Space Shuttle *Discovery* into Earth orbit in April 1990. It is a product of two decades of research and development by 10,000 scientists and engineers at various NASA Centers, private companies, universities, and the European Space Agency. The purpose of the Hubble, the most complex and sensitive optical telescope ever made, is to study the cosmos from low-Earth orbit for 15 years or more.

Scientific Objectives

Scientists designed the Hubble Space Telescope to provide fine detail imaging, produce ultraviolet images and spectra, and detect very faint objects. The Hubble is meeting these three objectives, even though the spacecraft experienced a shaky start.

Two months after its deployment in space, scientists detected a 2-micron spherical aberration in the primary mirror that affected the telescope's ability to focus faint light sources into a precise point. This imperfection was very slight, one-fiftieth the width of a human hair.

Computer processing overcame much of the defect, but a scheduled Space Shuttle servicing mission in 1993 permitted scientists to correct the problem. During four spacewalks, new instruments were installed into the Hubble that had optical corrections. A second servicing mission in 1997 further upgraded the instruments on the telescope.

Key Features

The Hubble Space Telescope is approximately the size of a railroad car, with two cylinders joined together and wrapped in a silvery reflective heat shield blanket. Wing-like solar arrays extend horizontally from each side of these cylinders, and dish-shaped antennas extend above and below the body of the telescope. The design is modular so the Space Shuttle can easily replace malfunctioning units.

The telescope has three major sections: the support systems module, the optical telescope assembly, and the scientific instruments. The support systems module holds the optical telescope assembly and scientific instruments in place and insulates them from extreme temperature highs and lows, when the satellite is in full light or darkness.

The support system includes the European Space Agency's solar arrays, which consist of two "wings" containing

48,000 solar cells. The pointing control system aims the telescope to a desired position and locks it in place within 0.01 arc second through a series of gyroscopes, star trackers, momentum wheels, electromagnets, and fine guidance sensors. In addition, computers, high-gain antennas, and an electrical power system allow the Hubble to receive commands and transmit data back to scientists on Earth.

The optical telescope assembly contains two secondary and one larger primary mirror (2.36 meters) to collect and focus light from selected celestial objects. The mirrors are housed near the center of the telescope. Light hits the primary mirror and bounces to the secondary mirror—to a focal plane where the scientific instruments are located.

The scientific instruments include the Wide Field/Planetary Camera, the Faint Object Camera, the Goddard High Resolution Spectrograph, the Faint Object Spectrograph, and the High Speed Photometer. The fine guidance system also performs scientific measurements. The instruments are positioned about 1.5 meters behind the primary mirror. The goals of these five instruments are as follows:

- The Wide Field/Planetary Camera 2 is designed to investigate the age of the universe and to search for new planetary systems around young stars. It takes pictures of large numbers of galaxies and of closeups of planets in our solar system.
- The Space Telescope Imaging Spectrograph will spread out light into its component colors so that the properties of celestial objects, such as chemical composition, radial velocity, rotational velocity, and magnetic fields, can be measured. The spectrograph is able to record the spectrum of many locations in a galaxy simultaneously.
- The Near Infrared Camera and Multi-Object Spectrometer is a cryogenically cooled instrument that provides the capability of infrared imaging and spectroscopic observations of astronomical targets. The instrument detects light with wavelengths longer than the human eye limit.
- The Faint Object Camera, a contribution of the European Space Agency, focuses on smaller areas than the other camera and is used for producing sharp images at great distances. The data produced from this camera will help determine the distance scale of the universe and peer into centers of globular star clusters, binary stars, and other faint phenomena.

Compton Gamma Ray Observatory

The Compton Gamma Ray Observatory (CGRO) is the second of the great observatory series of four spacecraft NASA plans to launch. Launched in 1991, the CGRO is a complex spacecraft fitted with four different gamma-ray detectors, each of which concentrates on different but overlapping energy ranges. The instruments are the largest of their kind that have ever flown in space; each instrument weighs about 6 tons, and three of them are about the size of a subcompact car. Size is important because gamma rays can only be detected when they interact with matter. The bigger the masses of the detectors, the greater the number of gamma rays they can detect.

Outer space is filled with electromagnetic radiation that tells the story of the birth and death of stars and galaxies. A small portion of that radiation is visible to our eyes. The rest can be detected only with special instruments. In a chart of the electromagnetic spectrum, gamma rays fall at the far right end after visible light, ultraviolet light, and x rays. Gamma rays have very short wavelengths and are extremely energetic, but most of them do not penetrate Earth's atmosphere. The only way for astronomers to view these waves is to send instruments into space.

The process for gamma-ray detection is similar to the way fluorescent paints convert ultraviolet light to visible light. When gamma rays interact with crystals, liquids, and other materials, they produce flashes of light that are recorded by electronic sensors. Astronomers can determine how energetic a particular ray is from the intensity of the flash—the brighter the flash of light from the interaction, the higher the energy of the ray.

Scientific Objectives

The CGRO helps astronomers learn about the most powerful celestial bodies and events in the universe. It observes momentous gamma-ray bursts, such as those near the large Magellanic Cloud, which radiate more gamma rays in 0.2 second than our Sun does in 1,000 years. The CGRO gathers data to test theories on supernovae and the structure and dynamics of galaxies. The data collected on pulsars will allow scientists to explain how pulsars can produce more energy over their lifetime than the explosion it took to create them. The CGRO also monitors quasars, the luminous bodies with unusually high-energy outputs commonly found in the center of galaxies. In addition, the observatory views very high-temperature emissions data from black holes, which will reveal information on the origin of the universe and matter distribution.

The Gamma Ray Detectors

The four different kinds of gamma ray detectors on the CGRO are the Burst and Transient Source Experiment (BATSE), the Oriented Scintillation Spectrometer Experiment (OSSE), the Imaging Compton Telescope (COMPTEL), and the Energetic Gamma Ray Experiment Telescope (EGRET). The following are brief descriptions of these detectors:

- BATSE consists of eight detectors, placed on the corners of the spacecraft, which monitor as much of the sky as possible for gamma ray bursts, because gamma-ray bursts are brief, random events. These bursts are in the lower energy range of gamma rays. However, because BATSE is the instrument with the widest view range when it detects higher range gamma rays, it signals the other instruments.
- OSSE uses four very precise crystal detectors primarily for plotting radioactive emissions from supernovae, pulsars, and novae. This experiment provides such information as temperature, particle velocities, and magnetic field strength.
- COMPTEL studies gamma rays with a higher energy range than OSSE. COMPTEL is a liquid detector that acts like a camera. Gamma rays enter through an initial detector, which is similar to a lens, and then pass through a second detector, which acts like film. In this way, COMPTEL reconstructs wide-field-view images of the sky. COMPTEL observes point sources, such as neutron stars, galaxies, and other diffuse emissions.
- EGRET detects the highest energy gamma rays, which are associated with the most energetic processes that occur in nature. EGRET was designed to collect data on quasars, black holes, stellar and galactic explosions, matter and anti-matter annihilation, and high-energy portions of gamma-ray bursts and solar flares. The highly sensitive instruments of EGRET can observe fainter sources than previously possible and with greater accuracy.

Chandra X-ray Observatory

NASA's Chandra X-ray Observatory (CXO) is the most sophisticated x-ray observatory ever built. It observes x-rays from high-energy regions of the universe, such as hot gas in the remnants of exploded stars. This observatory has three major parts: (1) the x-ray telescope, whose mirrors will focus x-rays from celestial objects; (2) science instruments, which record the x-rays so that x-ray images can be produced and analyzed; and (3) the spacecraft, which provides the environment necessary for the telescope and the instruments to work.

CXO will be boosted into an elliptical orbit by a built-in propulsion system. Two firings by an attached Inertial Upper Stage (IUS) rocket and three firings of its own onboard rocket motors after separating from the IUS will place the observatory into its working orbit. The onboard rocket motors, called the Integral Propulsion System, will also be used to move and aim the observatory. The orbit will take the spacecraft more than a third of the way to the Moon before returning to its closest approach to Earth of 10,000 kilometers. The time to complete an orbit will be 64 hours and 18 minutes.

The spacecraft will spend 85 percent of its orbit above the belts of charged particles that surround Earth. The radiation in these belts can overwhelm the observatory's sensitive instruments. Uninterrupted observations as long as 55 hours will be possible, and the overall percentage of useful observing time will be much greater than for the low-Earth orbit of a few hundred kilometers used by most satellites.

CXO's sensitivity will make it possible for more detailed studies of black holes, supernovae, and dark matter. It will also increase our understanding of the origin, evolution, and density of the universe.

Spacecraft System

The spacecraft system provides the support structure and environment necessary for the telescope and the science instruments to work as an observatory. For example, the sunshade door is one of most basic and important elements of the spacecraft system. This door remains closed until CXO has achieved pointing control in orbit. After being opened, it shadows the entrance of the telescope to allow it to point as close as 45 degrees to the Sun.

The thermal control system consists of a cooling radiator, insulators, heaters, and thermostats to control the temperatures of critical components of CXO. It is particularly important that the temperature near the x-ray mirrors be well controlled to keep the mirrors in focus. The temperature in many parts of the spacecraft is

continually monitored and reported back to mission control. The electrical power system generates electrical power from the solar arrays, stores it in three banks of batteries, and distributes it in a carefully regulated manner to the observatory. The solar arrays generate approximately 2 kilowatts of power for the heaters, science instruments, computers, transmitters, and so forth.

The communications, control, and data management system is the nerve center of the observatory. It keeps track of the position of the spacecraft in its orbit, monitors the spacecraft sensors, receives and processes commands from the ground for the operation of the observatory, and stores and processes the data from the instrument so that they can be transmitted to the ground. Typically, the data are transmitted to the ground during contacts with the NASA Deep Space Network about once every 8 hours.

The pointing control and aspect of determination system has gyros, an aspect camera, Earth and Sun sensors, and reaction wheels to monitor and control to very high accuracy where the telescope is pointing at any given moment. It is as if one could locate the bull's eye on a target 1 kilometer away to the precision of 3 millimeters—about the size of a pinhead. This system can also place the observatory into various levels of inactive, quiet states, known as "safe modes" of operation, during emergencies.

Scientific Instruments

The function of the science instruments is to record as accurately as possible the number, position, and energy of the incoming x-rays. This information can be used to make an x-ray image and study other properties of the source, such as its temperature.

The High Resolution Camera (HRC) will be one of two instruments used at the focus of CXO, where it will detect x-rays reflected from an assembly of eight mirrors. The unique capabilities of the HRC stem from the close match of its imaging capability to the focusing of the mirrors. When used with the CXO mirrors, the HRC will make images that reveal detail as small as one-half an arc second. This is equivalent to the ability to read a newspaper at a distance of 1 kilometer.

The primary components of the HRC are two Micro-Channel Plates. They each consist of a 10-centimeter-square cluster of 69 million tiny lead-oxide glass tubes that are about 10 microns in diameter (one-eighth the thickness of a human hair) and 1.2 millimeters long. The tubes have a special coating that causes electrons to be released when the tubes are struck by x-rays. These electrons are accelerated down the tube by a high volt-

age, releasing more electrons as they bounce off the sides of the tube. By the time they leave the end of the tube, they have created a cloud of 30 million electrons. A crossed grid of wires detects this electron signal and allows the position of the original x-ray to be determined with high precision. With this information, astronomers can create a finely detailed map of a cosmic x-ray source. The HRC will be especially useful for imaging hot matter in the remnants of exploded stars, in distant galaxies, and in clusters of galaxies and for identifying very faint sources.

The CXO CCD Imaging Spectrometer (ACIS) is the other focal plane instrument. As the name suggests, this instrument is an array of charged coupled devices (CCD's) similar to those used in a camcorder. This instrument will be especially useful because it can make x-ray images and measure the energies of incoming x-rays. It will be the instrument of choice for studying the temperature variation across x-ray sources, such as vast clouds of hot gas in intergalactic space.

In addition to the focal plane instruments, CXO will have two sets of finely ruled gratings, which can be swung into position between the mirrors and the focal plane. These gratings change the direction of incoming x-rays by amounts that depend sensi-

tively on their energies. When used with either the HRC or ACIS, they will allow for the precise determination of the energies of the x-rays. The grating spectrometers, as they are called, will be useful for studying the detailed energy spectrum of strong sources to determine the temperature and chemical composition.

The science instruments are mounted on the Science Instrument Module, which contains mechanisms to move the science instruments in and out of the focal plane. This module also has insulation for thermal control and electronics to control the operation of the science instruments via the communication, command, and data management systems of the spacecraft.

The science instruments will be controlled by commands transmitted from the Operations Control Center at the CXO Science Center in Cambridge, Massachusetts. A preplanned sequence of observations will be uplinked to CXO and stored in the on-board computer for later execution. Data collected by observations with CXO will be stored on a recorder for later transmission to the ground every 8 hours during the regularly scheduled Deep Space Network contacts. The data will then be transmitted to the Jet Propulsion Laboratory and then to the Operations Control Center for processing and analysis by scientists.

NASA Hubble Space Telescope Model

Materials and Tools

Sharp paper scissors
Razor blade knife
Dull knife
Sharp punch (such as an ice pick or nail)
Cutting surfaces (such as a wooden board)
Glue stick or rubber cement
Cellophane tape
5- by 5-centimeter-square piece of aluminum foil
Two 20-centimeter pieces of 1/8-inch dowel rods
Colored sharp point marker pens (yellow and red)
Blue and orange highlighter pens

General Assembly Tips

- Copy all model pieces on heavy weight paper.
- Color all pieces as indicated before cutting any parts out.
- Cut out only those pieces needed for the section being assembled at the time.
- Use a cutting surface such as a wooden board to protect the table or desk from scratches or gouges.
- Cut out pieces along the solid exterior lines.
- Using the dull knife, lightly score all dashed fold lines to make accurate folds possible.
- Apply glue to the insertion tabs on the pieces and flaps where the slots are located. If using rubber cement, apply cement to both surfaces to be joined and permit them to dry before assembling. Using a double coating of rubber cement makes a stronger bond. After the pieces are assembled, lightly rub pieces to remove excess.
- Some pieces may require small holes to be punched through them. Those places are indicated with the ⊕ symbol.

#1 Assembling the AFT SHROUD

1. Carefully cut out the following pieces: AFT SHROUD cylinder, END CAP, and INNER RING. Use the razor blade to cut small slits for the insertion of the assembly tabs of the cylinder.
2. Shape the AFT SHROUD cylinder by curling the paper around the edge of a table or desk. This will permit the paper to be easily rolled into a cylinder.
3. Curl the paper to form a tube, and insert the tabs of the cylinder into the slits cut in step 1. Hold the cylinder together with a piece of tape pressed to the inside.
4. Fold the tabs of the INNER RING downward. Dashed lines indicate where the folds should be. Coat each tab with glue, and lay the ring upside down on a flat surface. Place the cylinder over the INNER RING so that all tabs are inside.

The seam of the cylinder should align with the word "SMALL" on the INNER RING. Reach in with a finger and press each tab to the inside wall of the cylinder. You will need to support the outer wall of the cylinder with another finger to achieve a good bond.

5. Fold the tabs of the END CAP downward, and coat each with glue. Place the END CAP upside down on a flat surface, and place the other end of the cylinder over it. Press the tabs in place. If you have trouble reaching the tabs, use the eraser end of a pencil in place of your finger.
6. The AFT SHROUD is completed. Set it aside.

#2 Assembling the FORWARD SHELL and LIGHT SHIELD

1. Carefully cut out the FORWARD SHELL and LIGHT SHIELD assembly. Use the razor blade to cut the slits for the insertion of the assembly tab.
2. Shape the tube by pulling the paper over the edge of a table or desk.
3. Curl the paper to form a tube and insert the tabs into the slit. Use tape to hold the tube together.

#3 Joining the AFT SHROUD and the FORWARD SHELL and LIGHT SHIELD

1. Bend the four glue tabs at the lower end of the FORWARD SHELL and LIGHT SHIELD inward, and cover with glue.
2. Place the AFT SHROUD on a flat surface with the INNER RING pointed up. Insert the FORWARD SHELL and LIGHT SHIELD with the glue tab end down. Align the seam of the two cylinders.
3. Make sure the FORWARD SHELL and LIGHT SHIELD are standing straight up. Use a long piece of dowel rod to reach inside the tube, and press the tabs to the END CAP so that they will bond to the inside of the END CAP.

#4 Assembling the OTA EQUIPMENT SECTION

1. Carefully cut out the OTA EQUIPMENT SECTION. Cut the slots for tab insertion with the razor blade knife.
2. Curl the bay section to form a semicircle.
3. Fold the tabs downward and the curved sections downward.
4. Apply glue to the tabs, and insert them into the slots to join the segments as indicated in the diagram.

#5 Joining the OTA EQUIPMENT SECTION to the AFT SHROUD

1. Apply glue to the OTA EQUIPMENT SECTION where indicated.
2. Press the OTA EQUIPMENT SECTION to the INNER RING where indicated.

#6 Assembling the BARREL INSERT

1. Cut out the BARREL INSERT, MIRROR SUPPORT, and SECONDARY MIRROR SUPPORT.
2. Trace the circle of the MIRROR SUPPORT on the aluminum foil, and cut out the circle. Glue the foil to the MIRROR SUPPORT.
3. Glue the SECONDARY MIRROR SUPPORT onto the aluminum foil.
4. Cut the slits for the assembly tabs on the BARREL INSERT. Curl the paper to form a tube by dragging it over the edge of a table or desk.
5. Form the BARREL INSERT by rolling the paper, with the black side inward, and inserting the tabs into the slits. Hold the tube together by applying tape to the outside.
6. Fold the glue tabs of the MIRROR SUPPORT inward toward the foil side. Coat the tabs with glue. Bond the MIRROR SUPPORT to the end of the BARREL INSERT with the glue tabs to the outside.

#7 Joining the APERTURE DOOR to the BARREL INSERT

1. Cut out the APERTURE DOOR.
2. Apply glue to the back side of the middle glue tab and to the front side of the remaining two tabs.
3. Spread the glue tabs, and attach the APERTURE DOOR to one end of the BARREL INSERT over the seam. The middle tab should be on the inside and the other tabs on the outside. Press the tabs to the tube.

#8 Inserting the SOLAR ARRAY and ANTENNA Rods

1. Use the punch to make four small holes in the side of the FORWARD SHELL and LIGHT SHIELD at the places indicated. (Look for the ⊕.)
2. Carefully insert the two dowel rods into the holes so that each extends through to the opposite side. The ANTENNA rod is inserted through the holes closest to the AFT SHROUD. The SOLAR ARRAY rod is inserted through the holes closest to the APERTURE end of the FORWARD SHELL and LIGHT SHIELD.

#9 Assembling the SOLAR ARRAYS

1. Cut out each SOLAR ARRAY. Punch out the small circular holes in the two tabs. When the front and back sides of the arrays are together, both tabs should stick out. You will slide the tabs over the ends of the SOLAR ARRAY rod you inserted into the FORWARD SHELL and LIGHT SHIELD in the previous step.
2. Fold the two back side panels of each array along the dotted line. Coat the inside of the front array with glue, and press the back panels to it. When the glue is dry, slip the SOLAR ARRAY rod through the holes in the two tabs for each array.

#10 Assembling the ANTENNAS

1. Cut out the ANTENNAS.
2. Glue the back side of each ANTENNA assembly. Fold the front and back of each ANTENNA over the ends of the ANTENNA rod. Press the front and back together. Then, fold the reinforcing strips around the back of each ANTENNA to help hold the pieces together.

#11 Inserting the BARREL INSERT

1. Insert the BARREL INSERT into the FORWARD SHELL and LIGHT SHIELD so that the APERTURE DOOR is opposite the seam of the cylinder.

The NASA Hubble Space Telescope model is now complete. You can display it by suspending it from the ceiling by a piece of thread or monofilament fishing line or by creating a base for it.

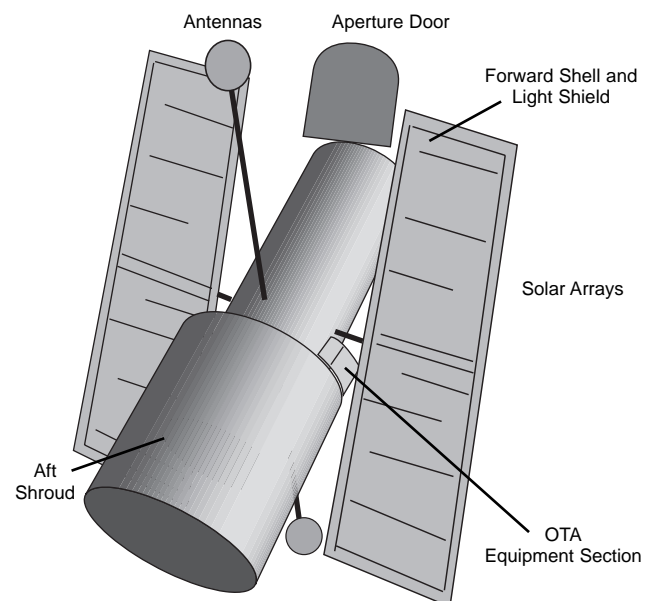

AFT SHROUD

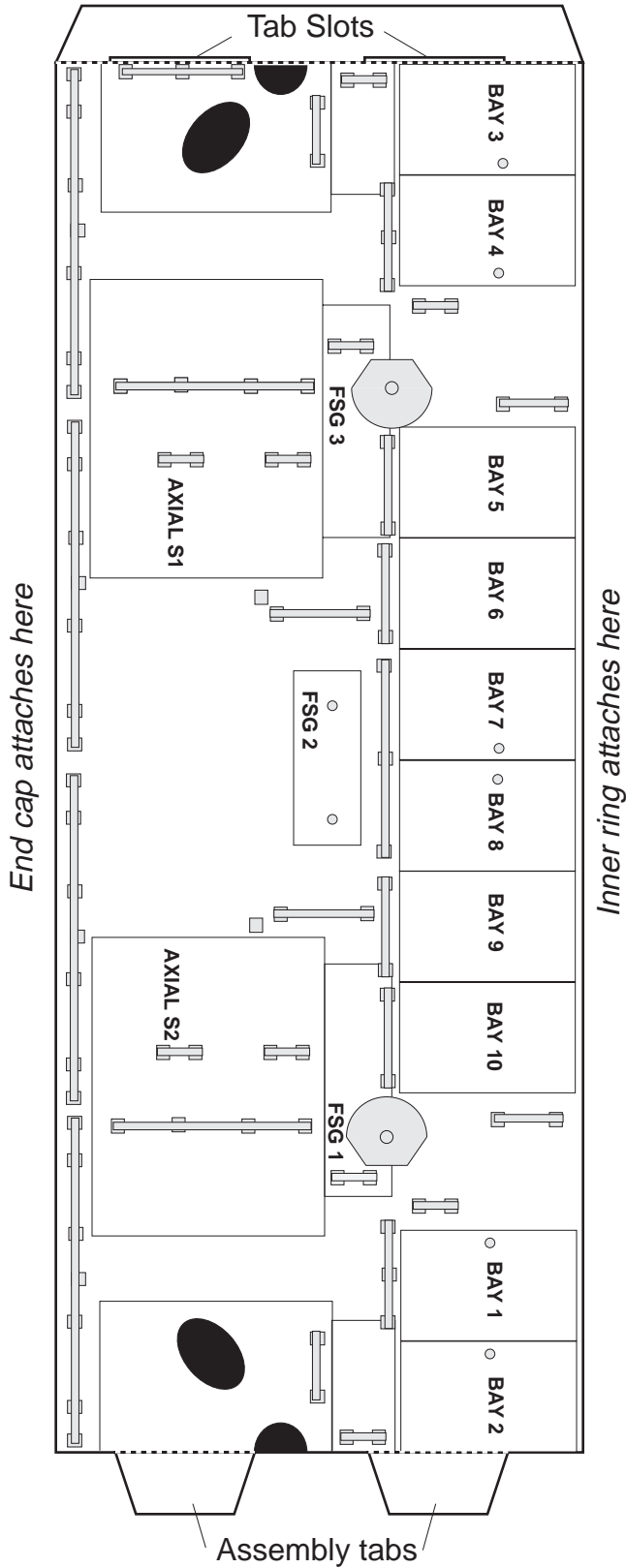

INNER RING

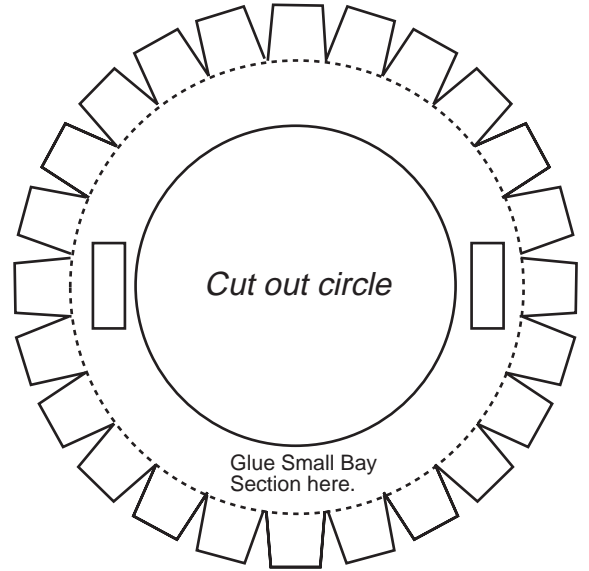

Color these features yellow

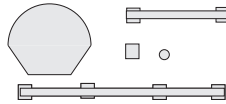

END CAP

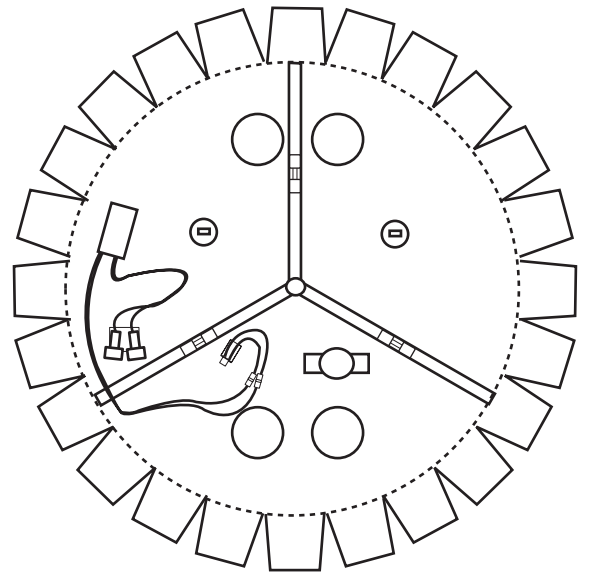

FORWARD SHELL AND LIGHT SHIELD

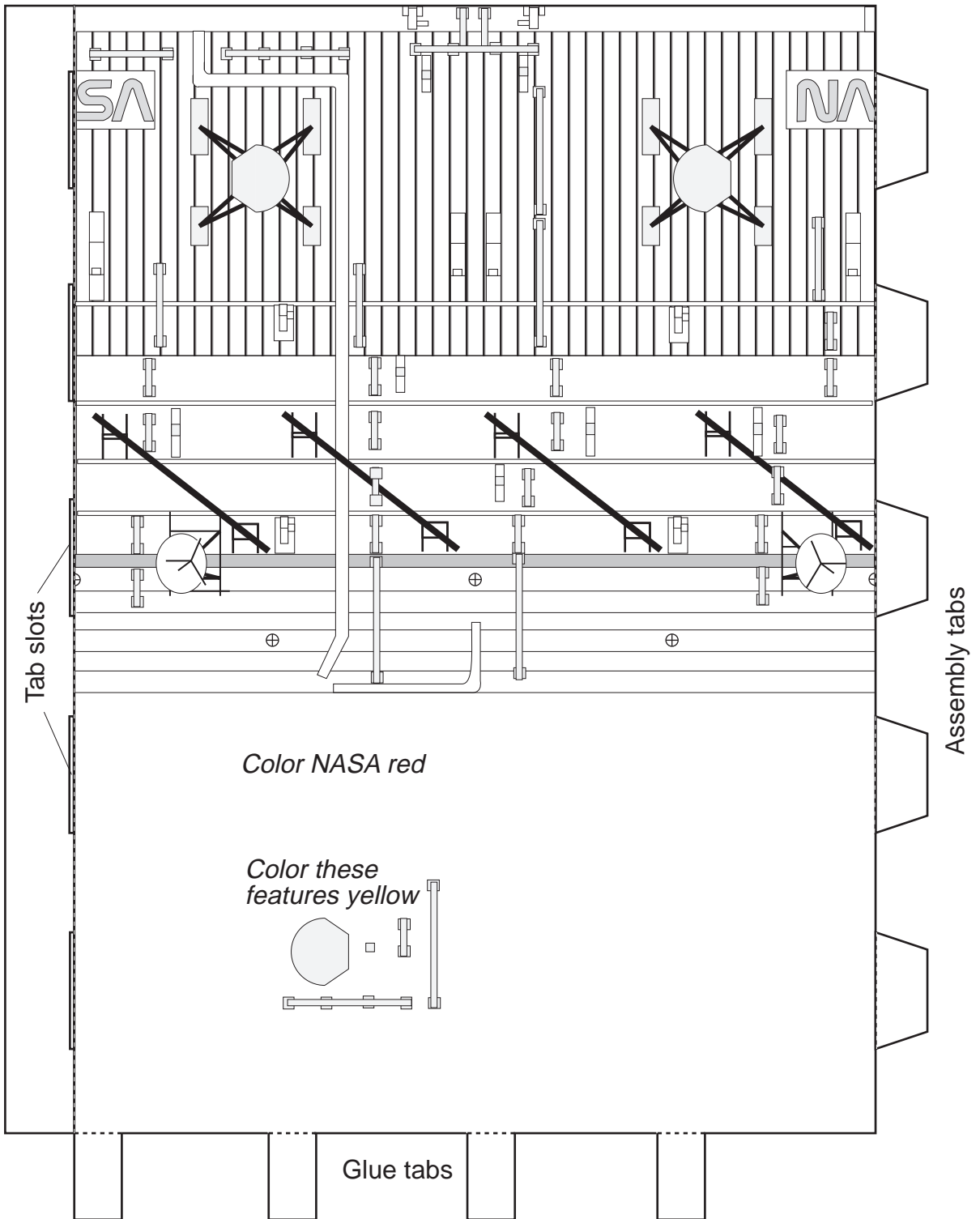

BARREL INSERT



APERTURE DOOR

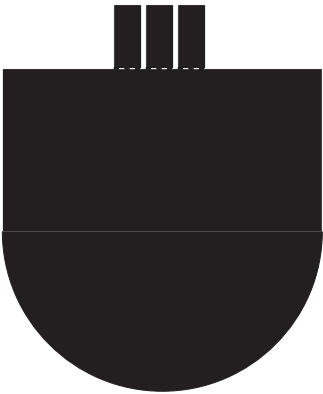

SECONDARY MIRROR SUPPORT

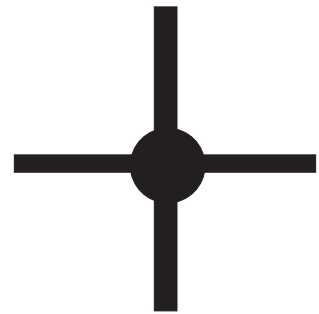

MIRROR SUPPORT

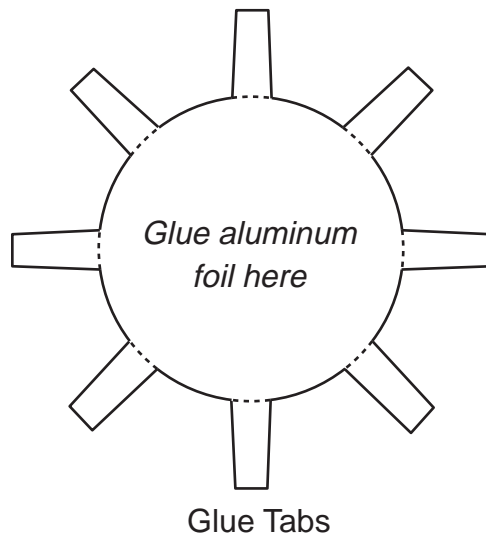

SOLAR ARRAYS

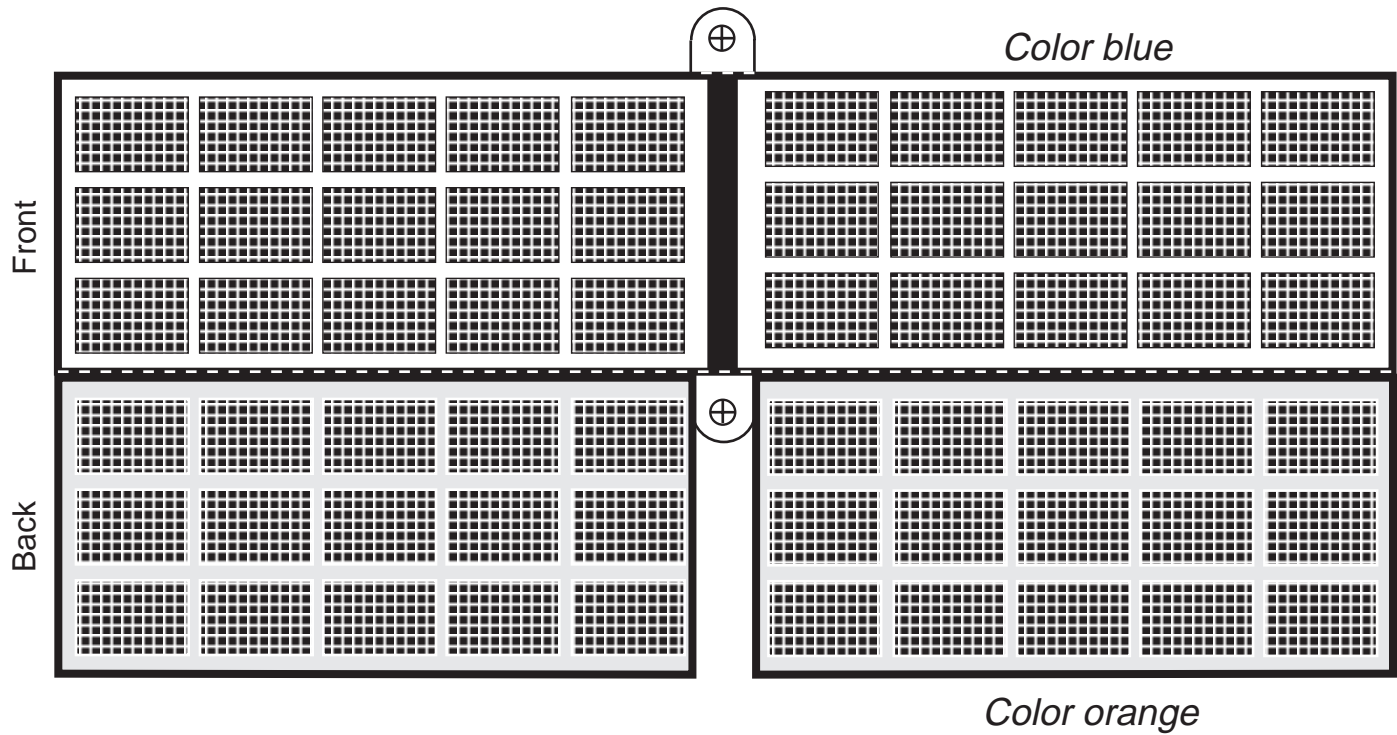
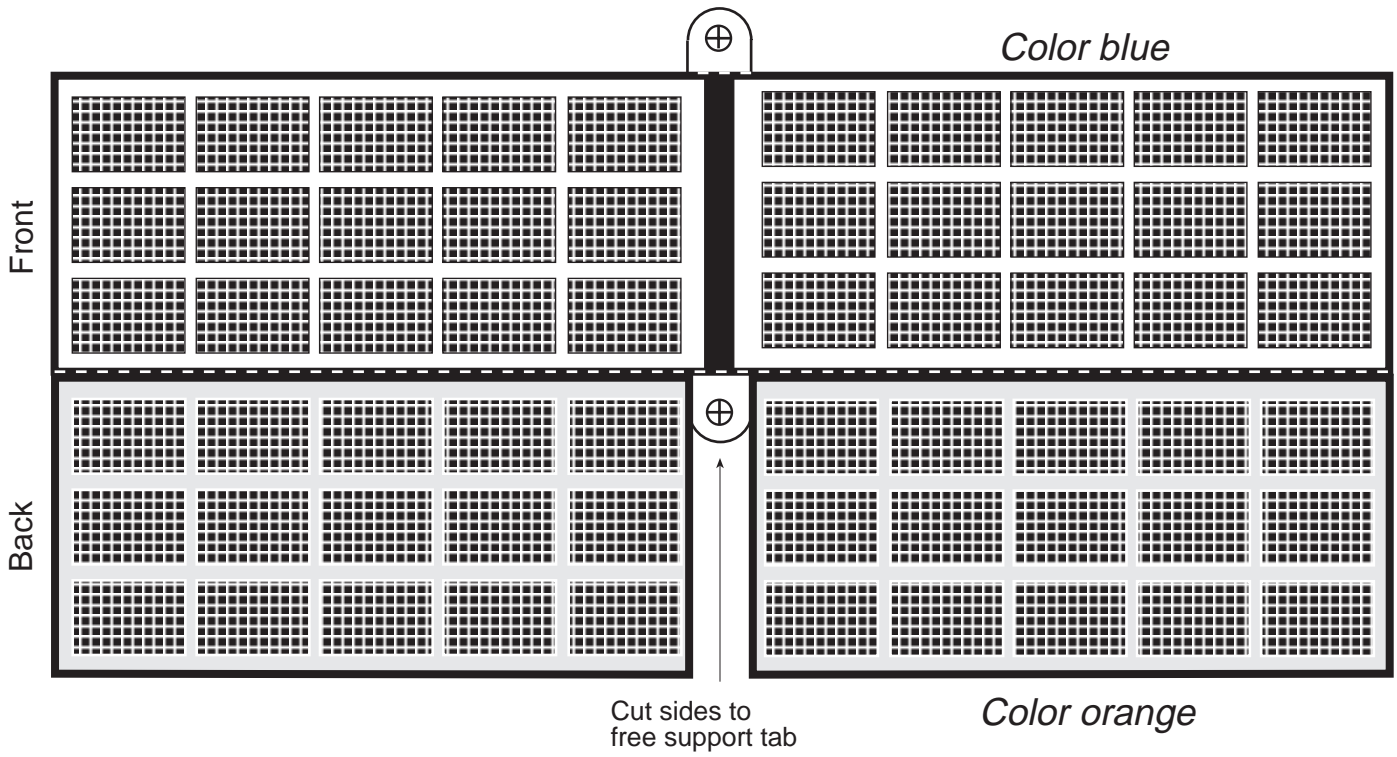

ANTENNAS

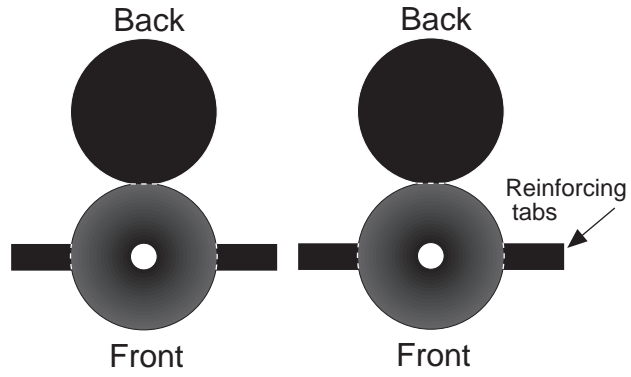

OTA EQUIPMENT SECTION

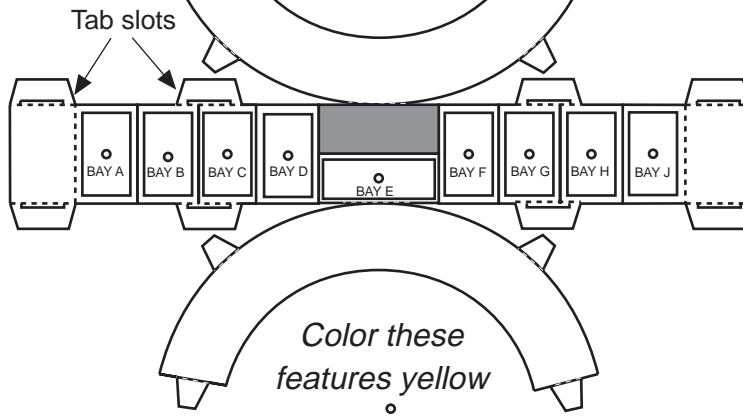

OTA ASSEMBLED

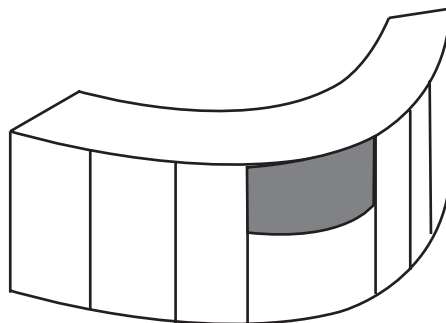

Compton Gamma Ray Observatory Model

Materials and Tools

Sharp paper scissors
Razor blade knife
Dull knife
Straight edge
Sharp punch (such as an ice pick or nail)
Glue stick or rubber cement
Cellophane tape
Cutting surface (such as a wooden board)
Silver paint or gray, yellow, and blue marker pens
Dowel rod (1/16-inch diameter)
Two Ping-Pong balls

General Assembly Tips

- Copy all model pieces on heavy weight paper.
- Color all pieces as indicated before cutting any parts out.
- Cut out only those pieces needed for the section being assembled at the time.
- Use a cutting surface such as a wooden board to protect the table or desk from scratches or gouges.
- Cut out pieces along the solid exterior lines.
- Using the dull knife, lightly score all dashed fold lines to make accurate folds possible.
- Apply glue to the insertion tabs on the pieces and flaps where the slots are located. If using rubber cement, apply cement to both surfaces to be joined, and permit them to dry before assembling. Using a double coating of rubber cement makes a stronger bond. After the pieces are assembled, lightly rub pieces to remove excess cement.
- Some pieces may require small holes to be punched through them. These places are indicated with the ⊕ symbol.

#1 Assembling the Bus

1. Be sure to punch out the holes for the SOLAR ARRAY rod out of the side of the BUS (look for the two ⊕ symbols), and cut out the holes for the OSSE, COMPTTEL, and EGRET.
2. This component is easiest to assemble by joining edge A to edge B. Follow with the assembly of the other sides.
3. Try to keep the joints square at all times, and smooth out any curves that might be produced.

#2 Assembling the Propellant Tanks

1. After forming the PROPELLANT TANKS, slip the four assembly tabs into the four slots in the bottom of the BUS. The notched end of the piece should be aligned with the OSSE end of the model. The ANTENNA rod will slide through this notch.

#3 Assembling the OSSE

1. Punch out the two holes indicated in the OSSE cradle. (Look for the ⊕.)
2. Begin joining each cradle by inserting tabs into the corresponding slots nearest the center folds. Work your way toward the upper end of the “U” shape.
3. Slide the cradles into their proper positions on the BUS. To make this easier, bend the assembly tabs upward, and gently push them into the corresponding slots. The tip of the razor blade knife can be used to assist in the insertion.
4. To provide extra strength to the model, glue the surfaces of the cradles and the PROPELLANT TANKS that touch together.
5. It is easiest to assemble the OSSE by folding around the curved side pieces before folding in the bottom.

#4 Assembling the COMPTTEL and EGRET

1. After joining each cylinder, glue and insert a Ping-Pong ball into the upper end of each. The Ping-Pong balls should form a dome at the upper end of each cylinder.
2. Insert the EGRET cylinder into the model first. Use a short piece of cellophane tape to anchor it in place. Insert the tape through the COMPTTEL hole. Next, insert the COMPTTEL cylinder. Bend the assembly tabs on the BUS upward, and slip them into the cylinder slots as it is pushed downward. For a better looking model, have the cylinder seams face each other.

#5 Assembling the BATSE

1. Score the fold lines before cutting out the pieces. After making all eight BATSE pieces, glue each to the model in the places indicated in the completed model diagram.

#6 Assembling the Solar Arrays

1. Be sure to punch the holes indicated in each array before cutting them out. (Look for the ⊕.)
2. Coat the back side of each array with glue, and fold them together along the dashed fold lines.
3. Cut one piece of dowel rod 45-centimeters long.
4. Slip the rod through the holes in the BUS.
5. Carefully slide one array onto each end of the rod. The rod is inserted through the holes cut open in step 6-1.

COMPLETED MODEL

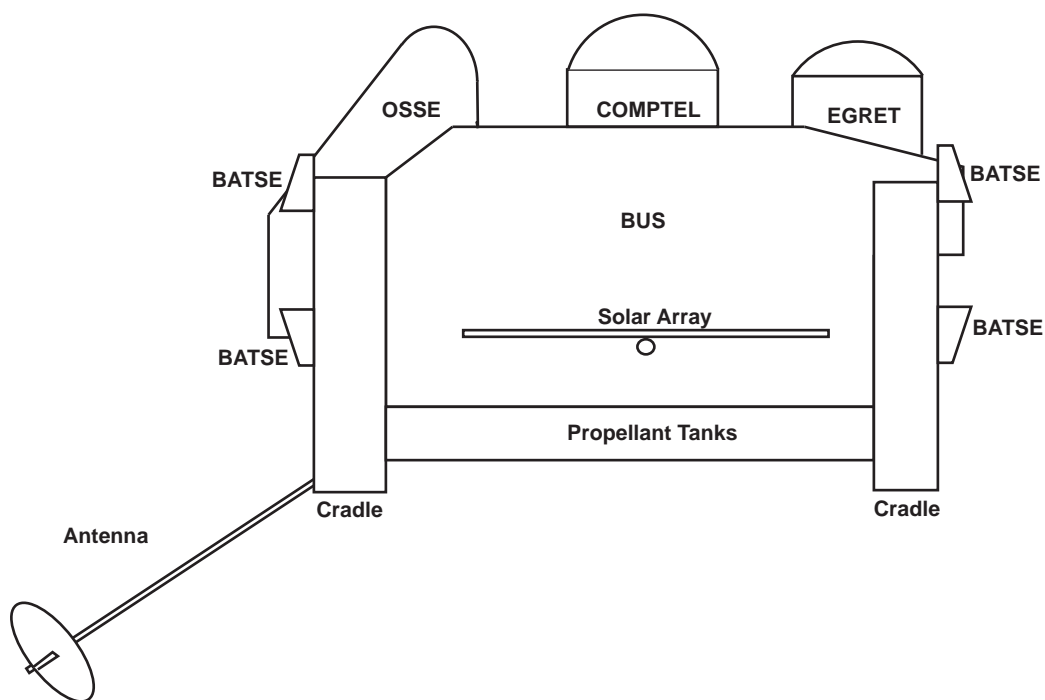

#7 Assembling the ANTENNA

1. Cut out both forms. Be sure to punch the holes first. (Look for the ⊕.)
2. Curl and glue the large form onto itself to form a shallow cone. Hold this piece together until the glue starts drying.
3. Coat the inside of the center of the cone and the back side of the smaller circle with glue. When dry, press the smaller circle into the center of the cone.
4. Cut a 14-centimeter piece from the remaining dowel rod. Slide the ANTENNA onto one end of the rod. Slip the other end of the rod through the holes in the bottom of the cradle on the OSSE end of the spacecraft.

The NASA Compton Gamma Ray Observatory model is now complete. You can display it by suspending it from the ceiling by a piece of thread or monofilament fishing line or by creating a base for it.

SPACECRAFT MODULE

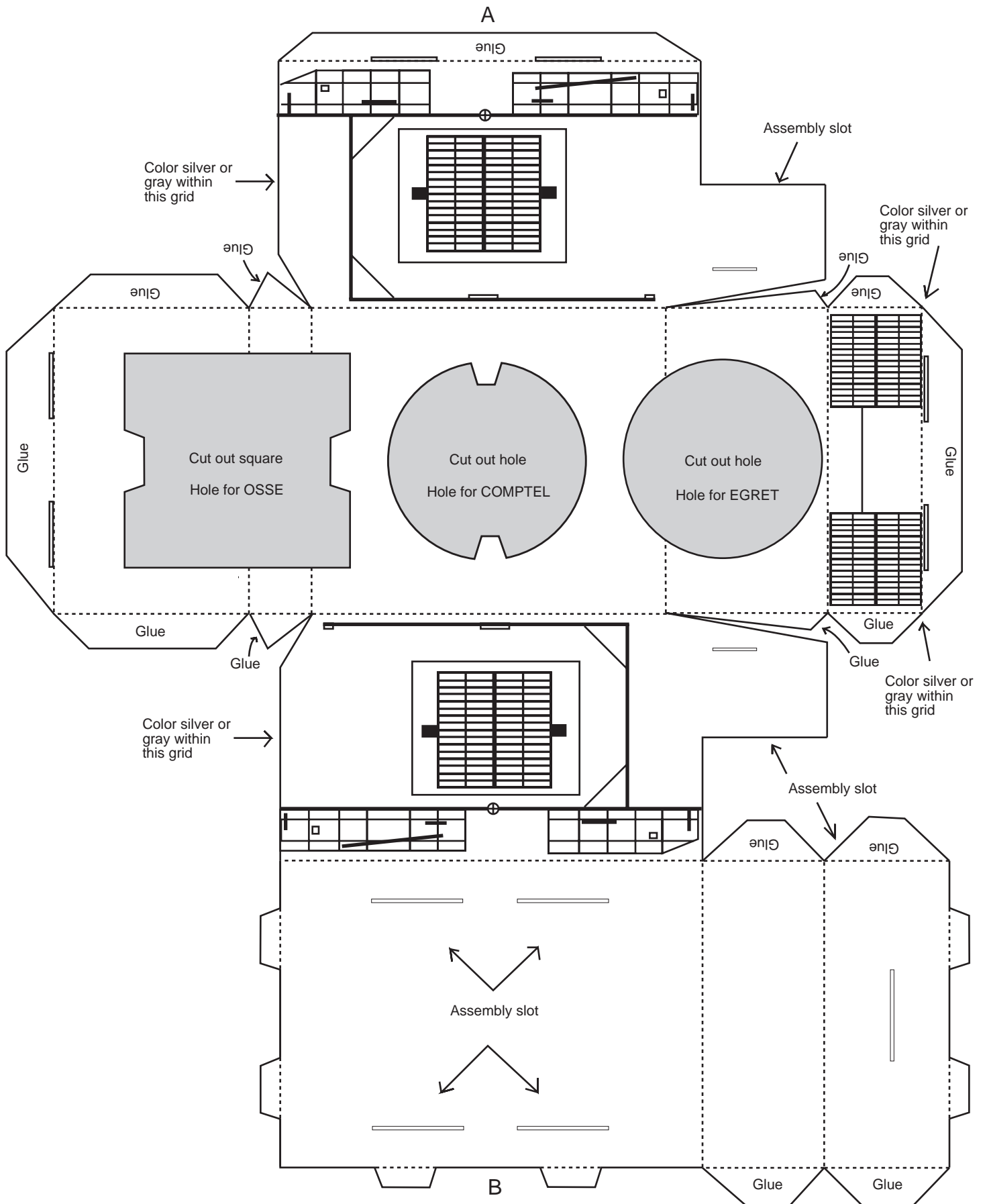

PROPELLANT TANKS

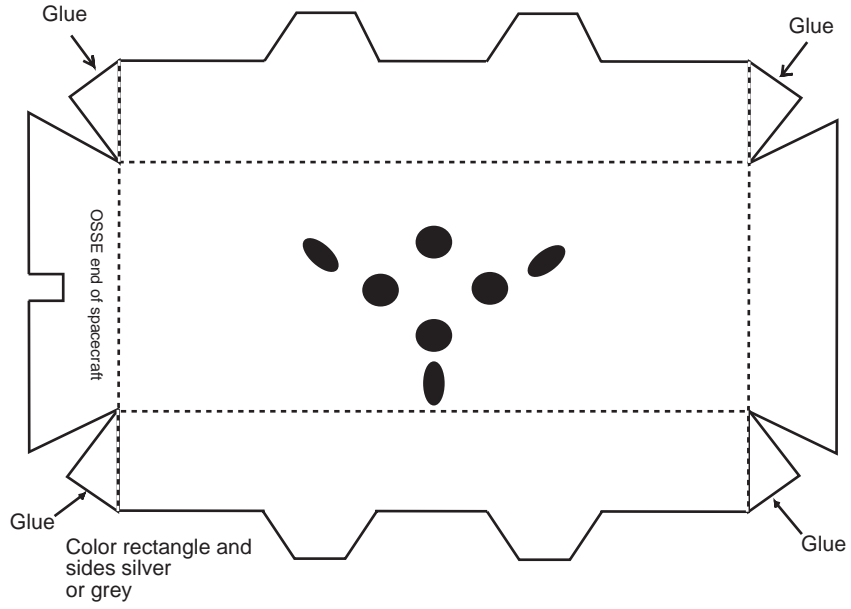

BATSE

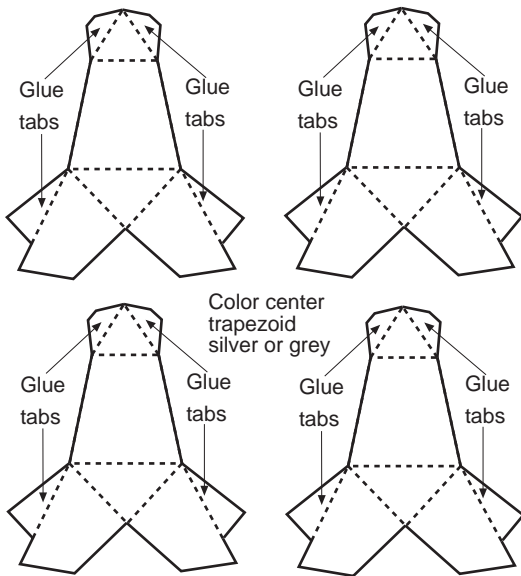

ANTENNA

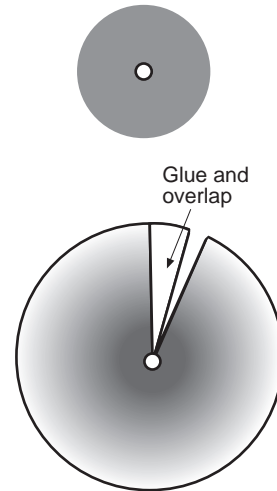

OSSE

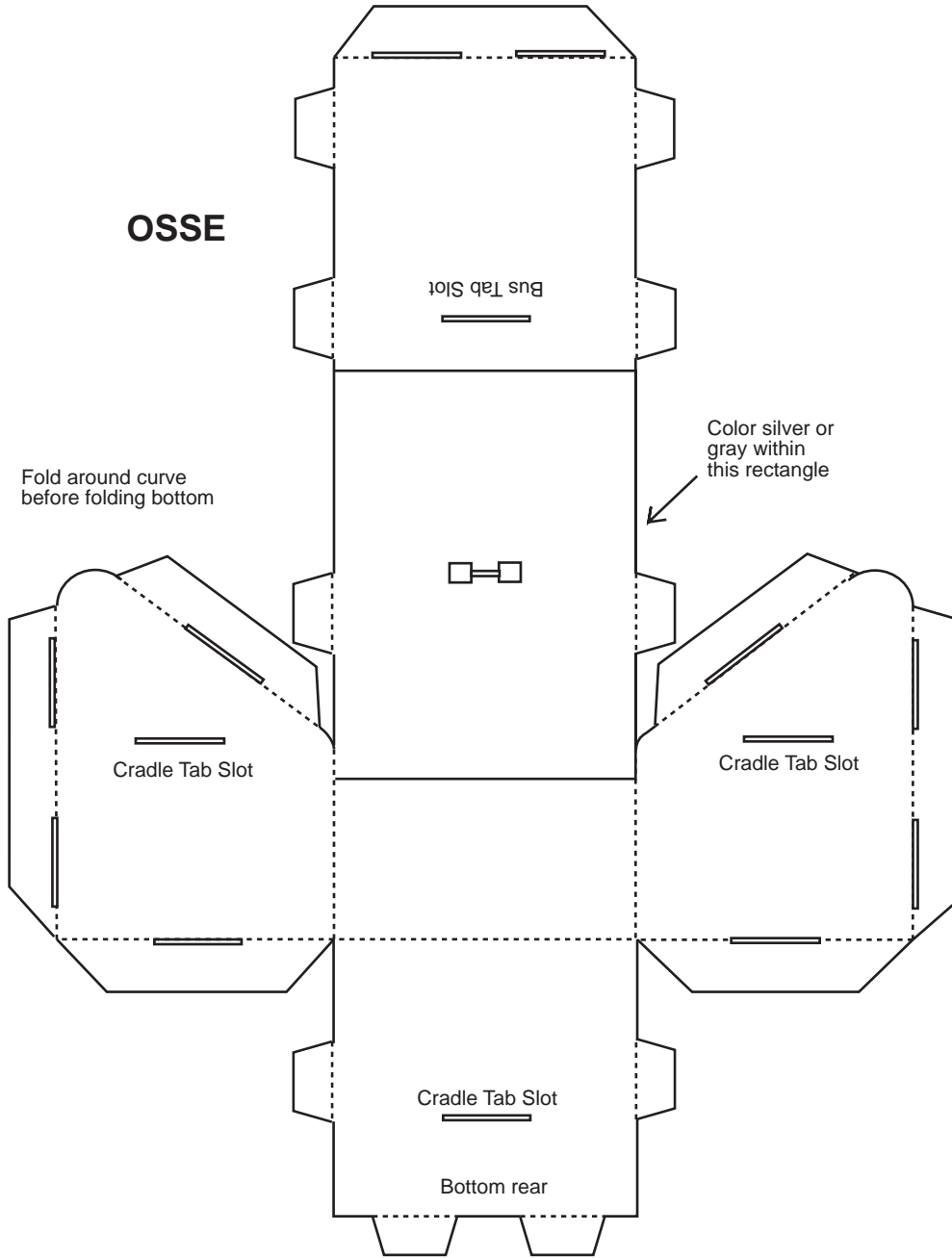

COMPTEL

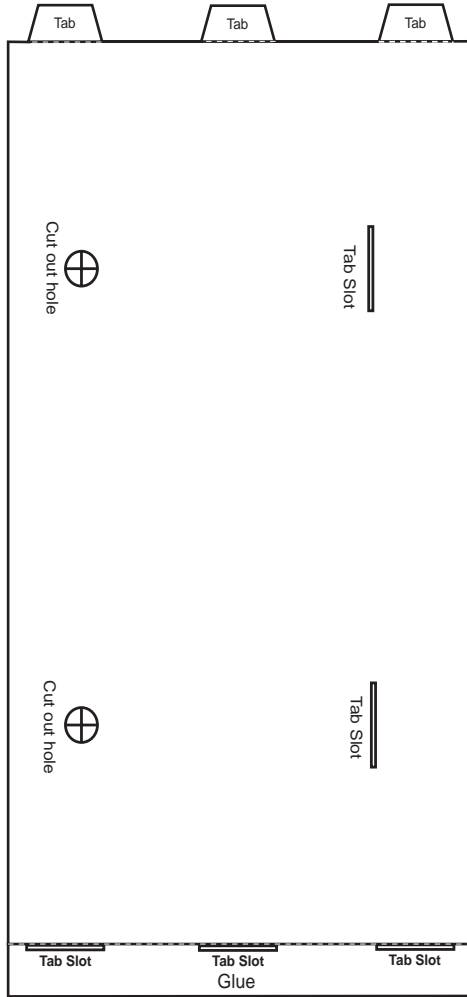

EGRET



CRADLES

Color circle and partial circle yellow

EGRET end

Color circle and partial circle yellow

Color circle and partial circle yellow

OSSE end

Color circle and partial circle yellow

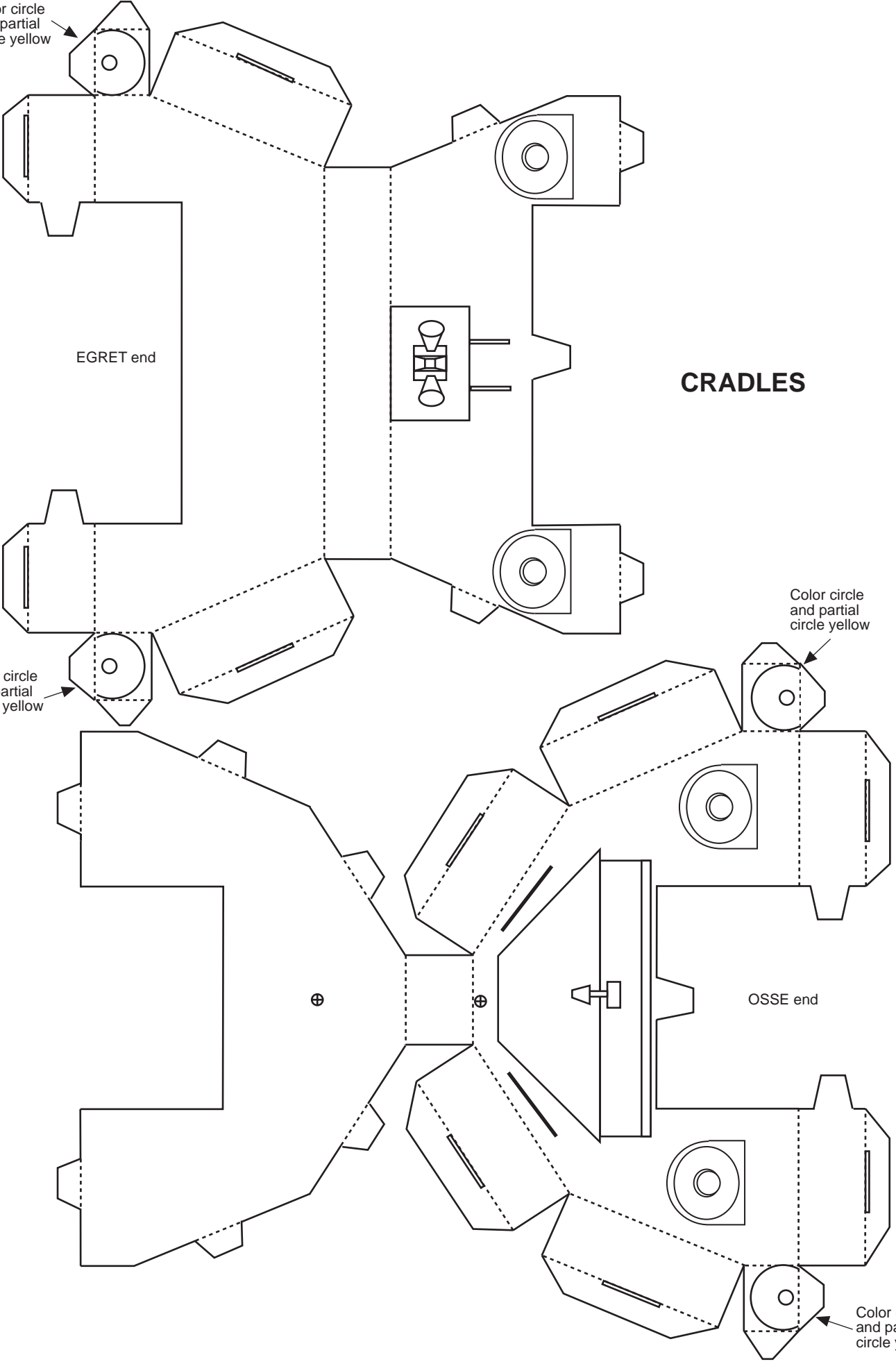

SOLAR ARRAYS

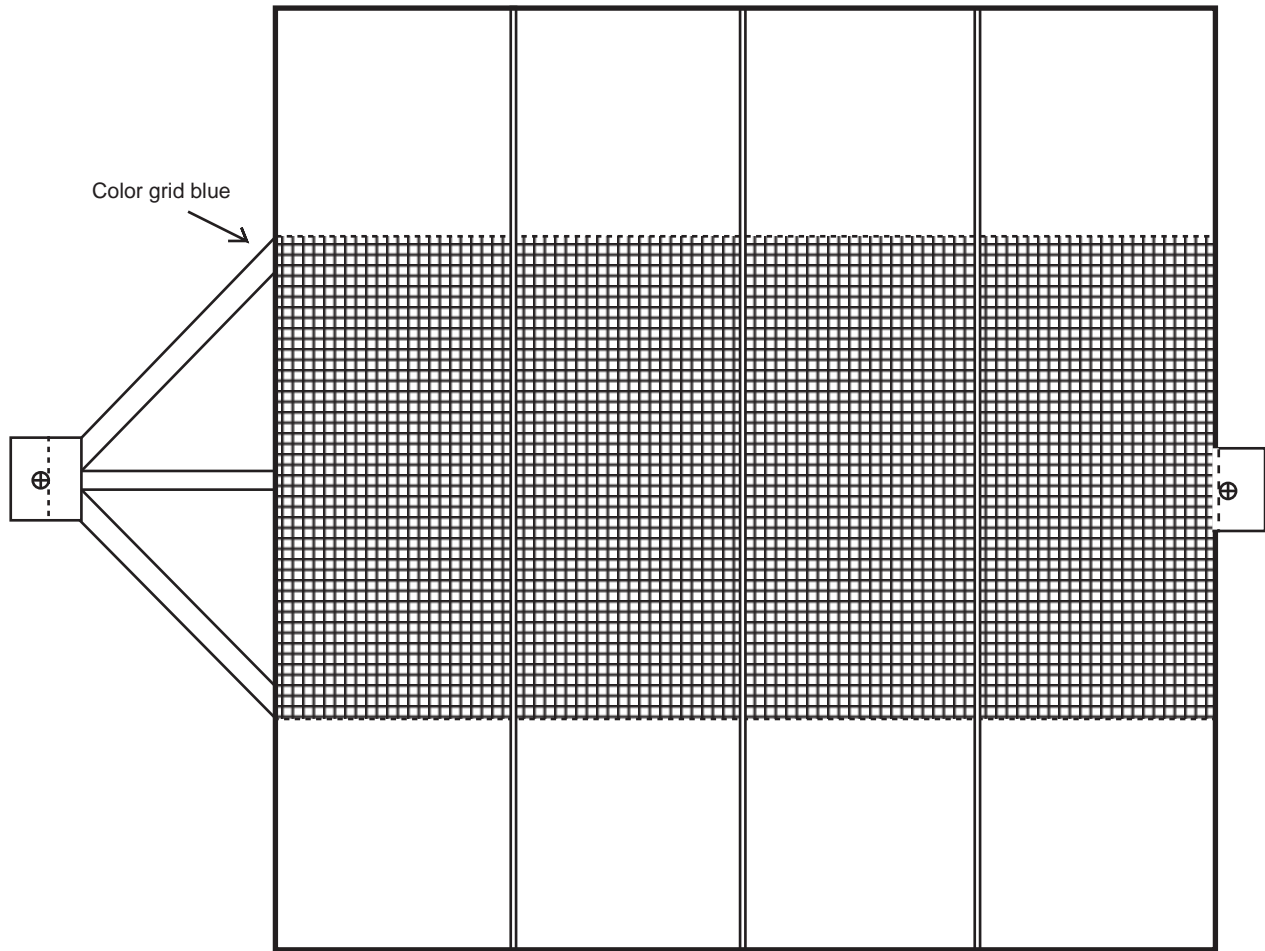
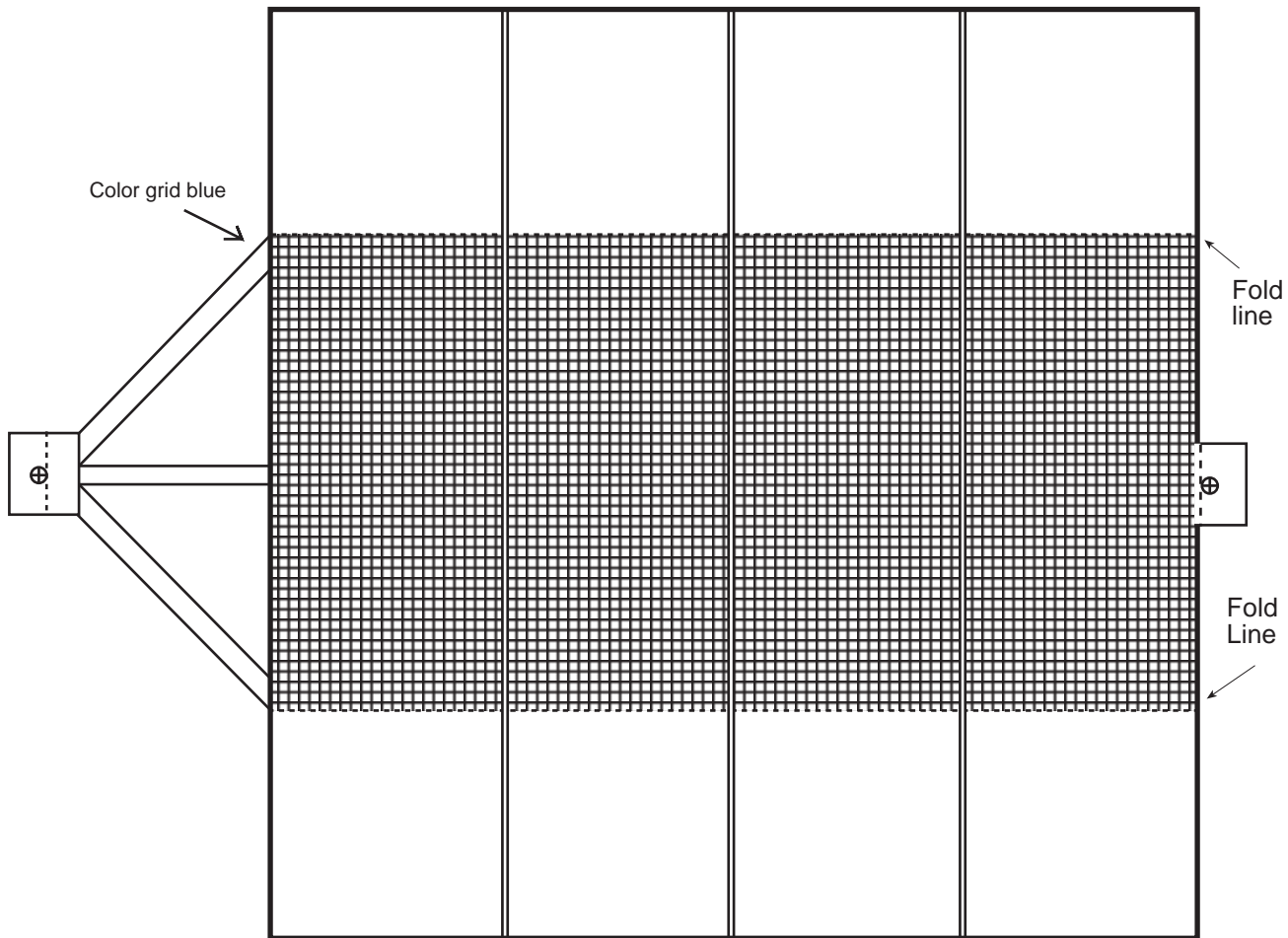

Chandra X-ray Observatory

Materials and Tools

Sharp paper scissors
Razor blade knife
Dull knife
Straight edge
Sharp punch (such as an ice pick or nail)
Glue stick or rubber cement and white glue
Cellophane tape
Cutting surface (such as a wooden board)
Silver paint or gold and blue marker pens
Dowel rod (1/16-inch diameter)—if a 1/16-inch dowel is not available, use a piece of thin wire coat hanger
Round toothpick

General Assembly Tips

- Copy all model pieces on heavy weight paper.
- Color all pieces as indicated before cutting any parts out.
- Cut out only those pieces needed for the section being assembled at the time.
- Use a cutting surface such as a wooden board to protect the table or desk from scratches or gouges.
- Cut out pieces along the solid exterior lines.
- Using the dull knife, lightly score all dashed fold lines to make accurate folds possible.
- Apply glue to the insertion tabs on the pieces and flaps where the slots are located. If using rubber cement, apply cement to both surfaces to be joined, and permit them to dry before assembling. Using a double coating of rubber cement makes a stronger bond. After the pieces are assembled, lightly rub pieces to remove excess cement.
- Some pieces may require small holes to be punched through them. These places are indicated with the ⊕ symbol.

#1 Assembling the TELESCOPE Tube

1. Color the tube gold where indicated.
2. Punch out the holes (⊕). One hole is lined up on the seam.
3. Cut out the part, and use the razor blade to open the five slots along the left side, six slots at the wide end of the TELESCOPE, and the slot in the piece marked "1."
4. Score the fold lines with the dull knife.
5. Curl the tube in your hands to shape it. Inset the tabs into the slots.
6. Close off the small end of the tube by folding inward piece 1, and insert the tab from piece 2 into the slot.

2# Assembling the SPACECRAFT MODULE

1. Cut out the SPACECRAFT MODULE, and score the fold lines for the module. Also cut out the assembly slots. Remember to cut the 16 assembly slots in the front end.
2. Punch out the holes (⊕).
3. Fold the module into a box shape. Use glue wherever possible to strengthen the structure.

#3 Joining the TELESCOPE and SPACECRAFT MODULE

1. Slip the narrow end the TELESCOPE through the large hole in the front end of the SPACECRAFT MODULE.
2. Align the tabs in the module with the four slots in the TELESCOPE. The holes in the module should be in a straight line with the holes in the TELESCOPE. A dowel will be inserted through both model pieces. The tip of the razor blade knife is a useful aid in slipping the tabs into the slots.

#4 Assembling the INTEGRATED SCIENCE INSTRUMENT MODULE

1. Cut out the INTEGRATED SCIENCE INSTRUMENT MODULE, open the six slots with the razor blade knife, and score the fold lines.
2. Fold the box together. The "arrowhead"-shaped ends will stick out from the completed part.
3. Cut the toothpick into two 1-centimeter-long pieces. Put a dab of white glue on each end of the pieces, and stand them up inside the "arrowhead" ends, as shown in the "ISIM COMPLETED" diagram. Set the part aside to dry.

#5 Assembling the HIGH RESOLUTION MIRROR ASSEMBLY and joining it to the TELESCOPE

1. Cut out the HIGH RESOLUTION MIRROR ASSEMBLY. Lightly fold downward the small triangles that extend to the sides of the small squares.
2. Coat the edge of the open end of the TELESCOPE with glue.
3. Push the mirror assembly onto the end of the TELESCOPE. Align the assembly so that the small black circle is at the position corresponding to 2:00 on a clock while the seam of the TELESCOPE is at the position corresponding to 6:00 on a clock.
4. Set the piece aside to dry. Check it occasionally to make sure the pieces are together.

#6 Assembling the SUNSHADE DOOR and joining it to the HIGH RESOLUTION MIRROR ASSEMBLY

1. Cut out the SUNSHADE DOOR, and glue the back sides together.
2. Fold the door where indicated.
3. When this piece is dry, glue it to the HIGH RESOLUTION MIRROR ASSEMBLY at the position corresponding to 12:00 on a clock.

#7 Assembling the SPACECRAFT MODULE EXTENSIONS and joining them to the SPACECRAFT MODULE

1. Cut out the two SPACECRAFT MODULE EXTENSIONS, open the slots with the razor blade knife, and score the fold lines.
2. Fold the pieces together.
3. Insert the lower two assembly tabs into the SPACECRAFT MODULE. Insert the third tab into the slot in the TELESCOPE.

#8 Assembling and joining the SMALL THRUSTERS to the SPACECRAFT MODULE

1. Cut out the smallest SMALL THRUSTERS, and fold them where indicated.
2. Insert the thrusters into the SPACECRAFT MODULE EXTENSIONS.
3. Cut out the larger thrusters, and fold them where indicated.
4. Insert these thrusters into the SPACECRAFT MODULE at the positions corresponding to 2:30 and 7:30 on a clock.

#9 Assembling and joining the LARGE THRUSTERS to the SPACECRAFT MODULE

1. Cut out the four LARGE THRUSTERS.
2. Curl the paper, and insert the tab into the slot. Fold the upper end down, and insert the tab into the slot. When completed, the LARGE THRUSTER should look like the diagram.
3. Insert the remaining two tabs of each thruster into the remaining slots of the SPACECRAFT MODULE.

#10 Assembling the SOLAR ARRAYS

1. Color the SOLAR ARRAYS blue and gold where indicated.
2. Cut out and score the two arrays for folding.

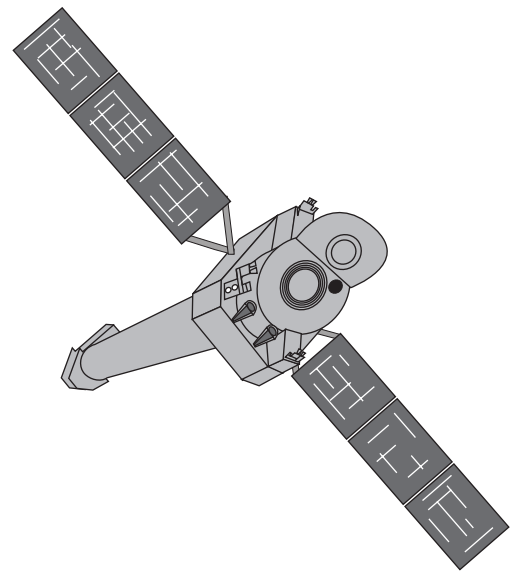

3. Fold over, and glue the back to the front. There will be a white gap running lengthwise on the back of each array.
4. Cut a 38-centimeter-long piece of the dowel.
5. Insert the dowel through the holes in the SPACECRAFT MODULE.
6. With the dowel centered, glue the SOLAR ARRAYS to the dowel. Glue them along the white gap on the array back sides. The arrays should face the same direction.

#11 Making the LOW GAIN ANTENNA

1. Cut an 8-centimeter piece of the dowel. Using the razor blade knife, sharpen each end to a point.
2. Insert the dowel through the remaining holes of the TELESCOPE.

#12 Completing CXO

1. Join the INTEGRATED SCIENCE INSTRUMENT MODULE to the small end of the TELESCOPE by inserting the two tabs from the TELESCOPE into the slots of the module.
2. Add some glue here to hold the module securely.

The NASA Chandra X-ray Observatory model is now complete. You can display it by suspending it from the ceiling by a piece of thread or monofilament fishing line or by creating a base for it.

Model Builder Note: NASA is planning a fourth great observatory to study infrared wavelengths. When the Space Infrared Telescope Facility (SIRTF) is near launch, a model of this spacecraft will be added to the set.

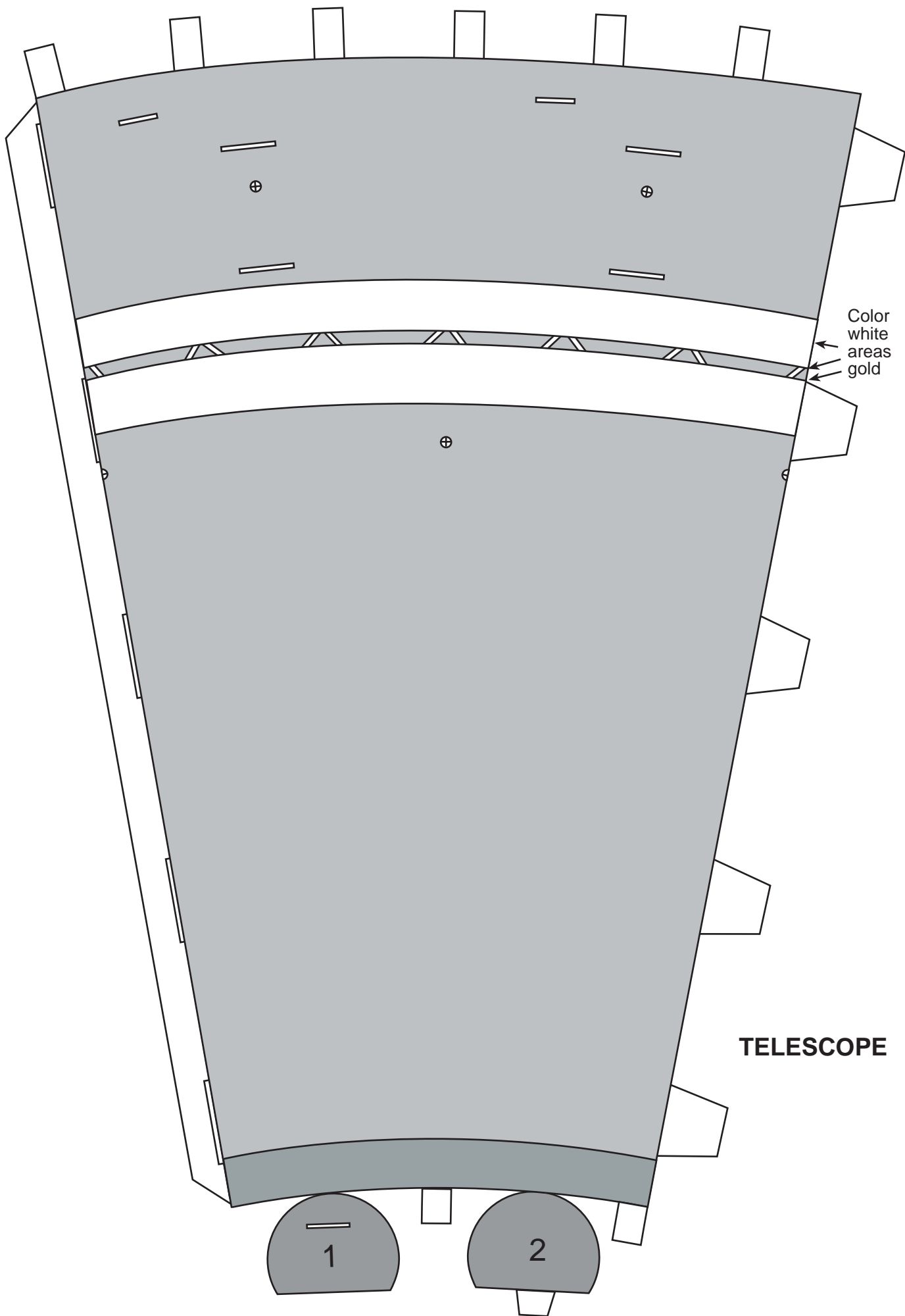

Color
white
areas
gold

TELESCOPE

1

2

SPACECRAFT MODULE

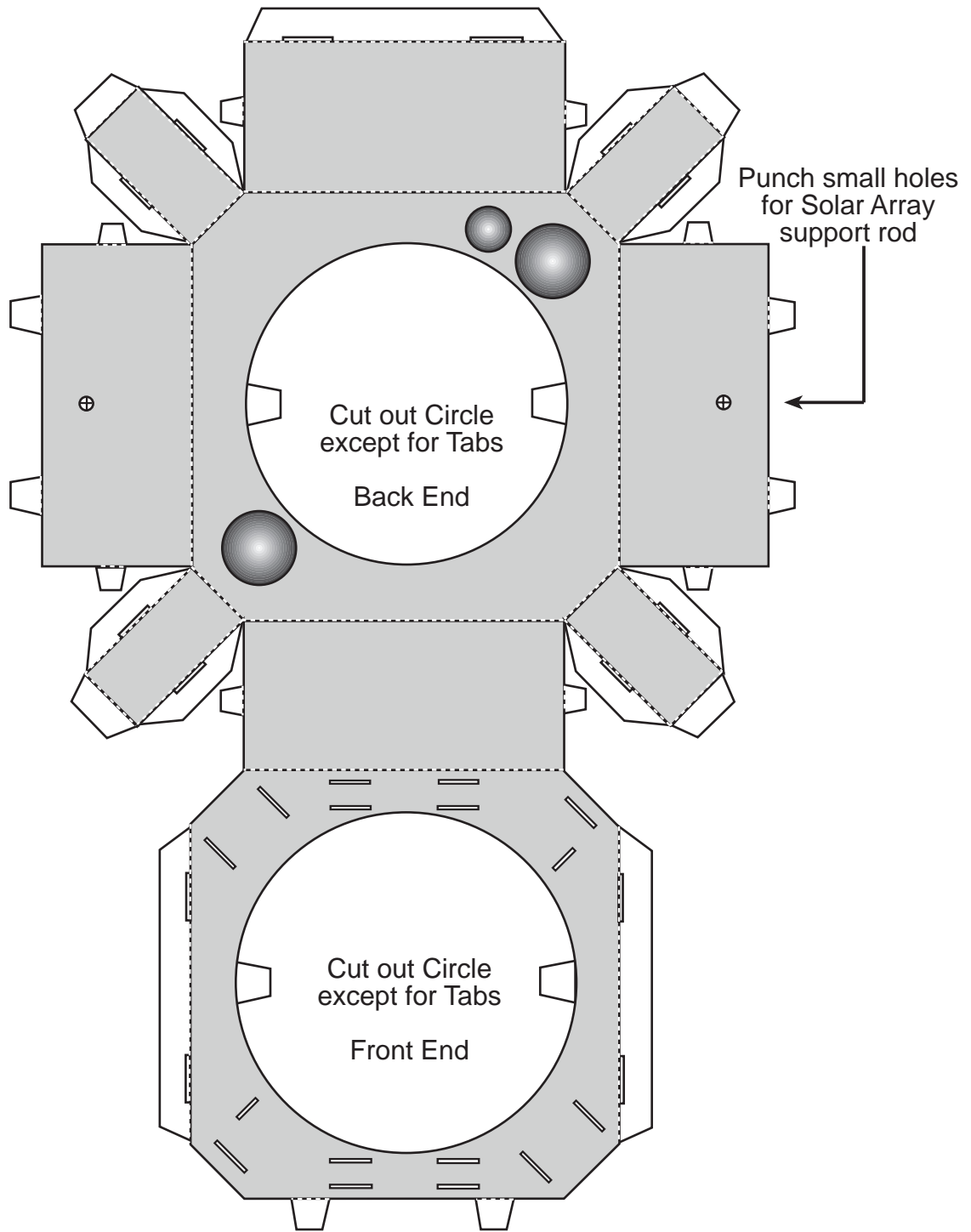

**INTEGRATED SCIENCE
INSTRUMENT MODULE
COMPLETED**

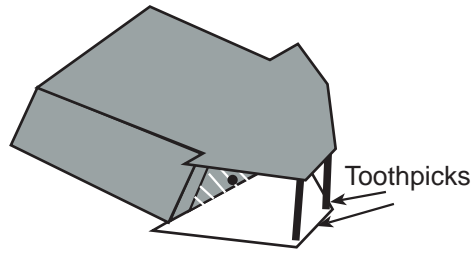

**INTEGRATED SCIENCE
INSTRUMENT MODULE**

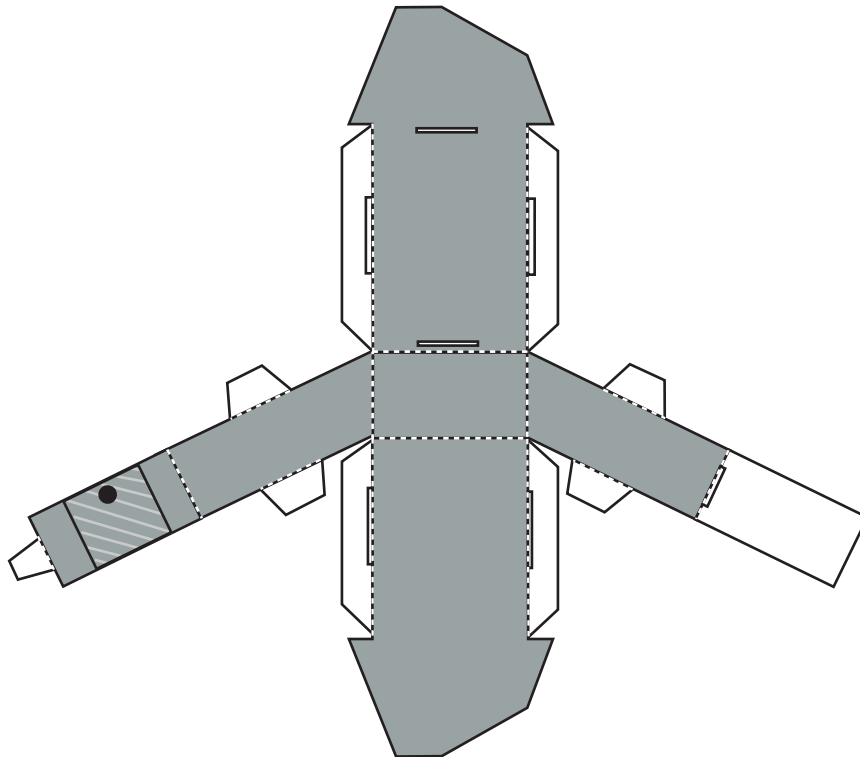

HIGH RESOLUTION MIRROR ASSEMBLY

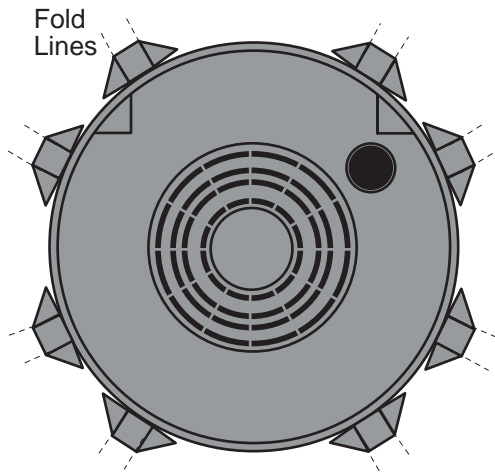

SUNSHADE DOOR

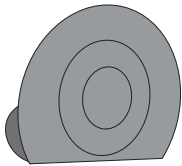

Sunshade Door looks like this when finished

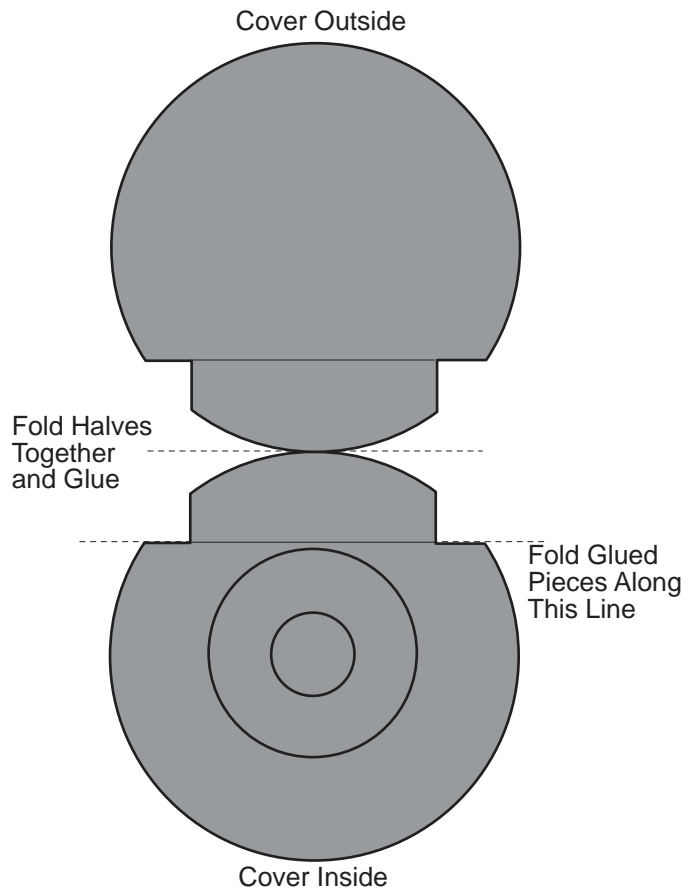

SPACECRAFT MODULE EXTENSIONS

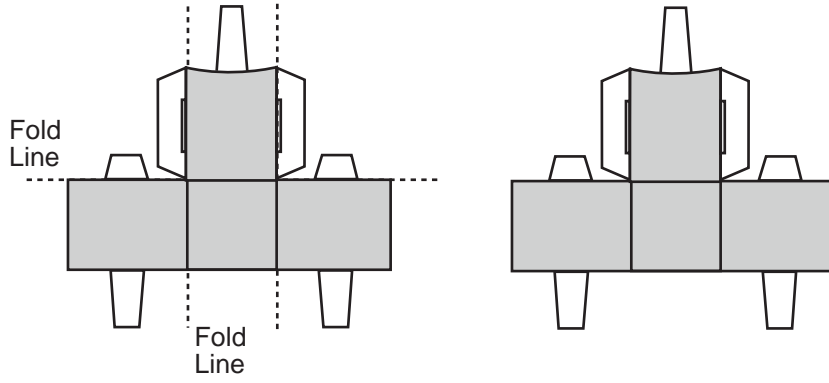

LARGE THRUSTERS

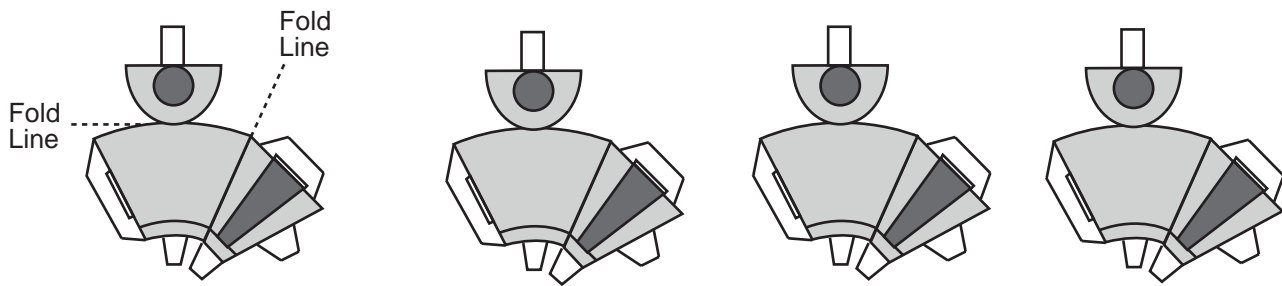

LARGE THRUSTER COMPLETE



SMALL THRUSTERS

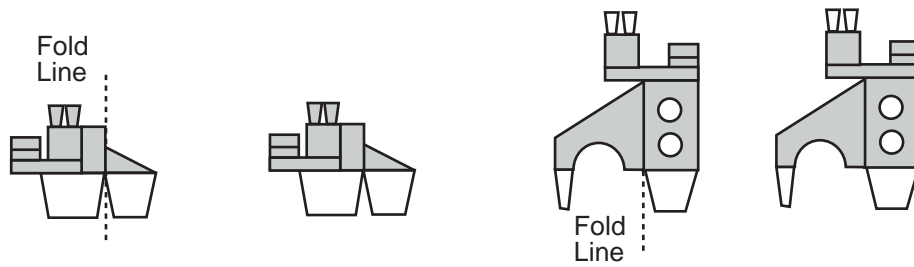

SOLAR ARRAYS

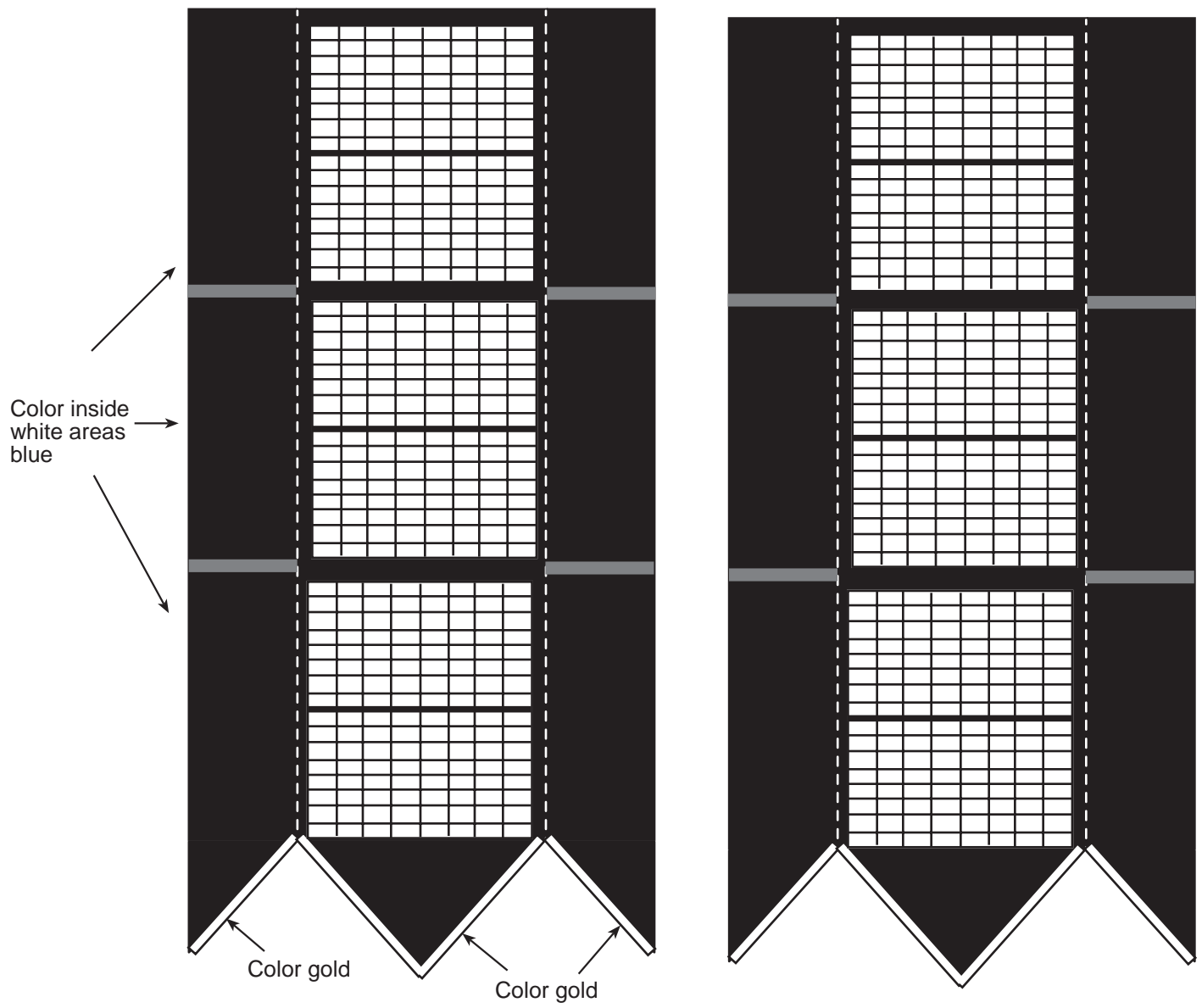

NASA Resources for Educators

NASA's Central Operation of Resources for Educators (CORE) was established for the national and international distribution of NASA-produced educational materials in audiovisual format. Educators can obtain a catalog and an order form by one of the following methods:

- NASA CORE
Lorain County Joint Vocational School
15181 State Route 58
Oberlin, OH 44074-9799
- Phone: (440) 774-1051, ext. 235 or 249
- Fax: (440) 774-2144
- E-mail: nasaco@leeca.esu.k12.oh.us
- Home Page: <http://spacelink.nasa.gov/CORE>

Educator Resource Center Network

To make additional information available to the education community, the NASA Education Division has created the NASA Educator Resource Center (ERC) Network. ERCs contain a wealth of information for educators: publications, reference books, slide sets, audio cassettes, videotapes, telelecture programs, computer programs, lesson plans, and teacher guides with activities. Educators may preview, copy, or receive NASA materials at these sites. Because each NASA Field Center has its own areas of expertise, no two ERCs are exactly alike. Phone calls are welcome if you are unable to visit the ERC that serves your geographic area. A list of the centers and the regions they serve includes:

AK, AZ, CA, HI, ID, MT, NV, OR, UT, WA, WY

NASA Educator Resource Center
Mail Stop 253-2

NASA Ames Research Center

Moffett Field, CA 94035-1000
Phone: (650) 604-3574

CT, DE, DC, ME, MD, MA, NH, NJ, NY, PA, RI, VT

NASA Educator Resource Laboratory
Mail Code 130.3

NASA Goddard Space Flight Center

Greenbelt, MD 20771-0001
Phone: (301) 286-8570

CO, KS, NE, NM, ND, OK, SD, TX

JSC Educator Resource Center
Space Center Houston

NASA Johnson Space Center

1601 NASA Road One
Houston, TX 77058-3696
Phone: (281) 483-8696

FL, GA, PR, VI

NASA Educator Resource Laboratory
Mail Code ERL

NASA Kennedy Space Center

Kennedy Space Center, FL 32899-0001
Phone: (407) 867-4090

KY, NC, SC, VA, WV

Virginia Air and Space Museum
NASA Educator Resource Center for

NASA Langley Research Center

600 Settler's Landing Road
Hampton, VA 23669-4033
Phone: (757) 727-0900, ext. 757

IL, IN, MI, MN, OH, WI

NASA Educator Resource Center
Mail Stop 8-1

NASA Lewis Research Center

21000 Brookpark Road
Cleveland, OH 44135-3191
Phone: (216) 433-2017

AL, AR, IA, LA, MO, TN

U.S. Space and Rocket Center
NASA Educator Resource Center for
NASA Marshall Space Flight Center
P.O. Box 070015
Huntsville, AL 35807-7015
Phone: (205) 544-5812

MS

NASA Educator Resource Center
Building 1200

NASA John C. Stennis Space Center

Stennis Space Center, MS 39529-6000
Phone: (228) 688-3338

NASA Educator Resource Center
JPL Educational Outreach
Mail Stop 601-107

NASA Jet Propulsion Laboratory

4800 Oak Grove Drive
Pasadena, CA 91109-8099
Phone: (818) 354-6916

CA cities near the center

NASA Educator Resource Center

NASA Dryden Flight Research Center

45108 N. 3rd Street East

Lancaster, CA 93535

Phone: (805) 948-7347

VA and MD's Eastern Shores

NASA Educator Resource Lab

Education Complex - Visitor Center Building J-1

NASA Wallops Flight Facility

Wallops Island, VA 23337-5099

Phone: (757) 824-2297/2298

Regional Educator Resource Centers (RERCs) offer more educators access to NASA educational materials. NASA has formed partnerships with universities, museums, and other educational institutions to serve as RERCs in many states. A complete list of RERCs is available through CORE, or electronically via NASA Spacelink at <http://spacelink.nasa.gov>

NASA's Education Home Page

NASA's Education Home Page serves as a cyber-gateway to information regarding educational programs and services offered by NASA for educators and students across the United States. This high-level directory of information provides specific details and points of contact for all of NASA's educational efforts and Field Center offices.

Educators and students utilizing this site will have access to a comprehensive overview of NASA's educational programs and services, along with a searchable program inventory that has cataloged NASA's educational programs. NASA's on-line resources specifically designed for the educational community are highlighted, as well as home pages offered by NASA's four areas of research and development (including the Aero-Space Technology, Earth Science, Human Exploration and Development of Space, and Space Science Enterprises).

Visit this resource at the following address:

<http://education.nasa.gov>

NASA Spacelink

NASA Spacelink is one of NASA's electronic resources specifically developed for the educational community. Spacelink is a "virtual library" in which local files and hundreds of NASA World Wide Web links are arranged in a manner familiar to educators.

Using the Spacelink search engine, educators can search this virtual library to find information regardless of its location within NASA. Special events, missions, and intriguing NASA web sites are featured in Spacelink's "Hot Topics" and "Cool Picks" areas.

Spacelink is the official home to electronic versions of NASA's Educational Products. NASA educator guides, educational briefs, lithographs, and other materials are cross-referenced throughout Spacelink with related topics and events. Spacelink is also host to the NASA Television Education File schedule. NASA Educational Products can be accessed at the following address: <http://spacelink.nasa.gov/products>

Educators can learn about new NASA Educational Products by subscribing to Spacelink EXPRESS. Spacelink EXPRESS is an electronic mailing list that informs subscribers quickly by e-mail when new NASA educational publications become available on Spacelink.

Spacelink may be accessed at the following address:

<http://spacelink.nasa.gov>

Join the NASA Spacelink EXPRESS mailing list to receive announcements of new NASA materials and opportunities for educators. Our goal is to inform you as quickly as possible when new NASA educational publications become available on Spacelink: <http://spacelink.nasa.gov/xh/express.html>

NASA Television (NTV)

NASA Television (NTV) features Space Shuttle mission coverage, live special events, interactive educational live shows, electronic field trips, aviation and space news, and historical NASA footage. Programming has a 3-hour block—Video (News) File, NASA Gallery, and Education File—beginning at noon Eastern and repeated three more times throughout the day.

The Education File features programming for teachers and students on science, mathematics, and technology, including *NASA . . . On the Cutting Edge*, a series of educational live shows. Spacelink is also host to the NTV Education File schedule at: <http://spacelink.nasa.gov/NASA.News/>

These interactive live shows let viewers electronically explore the NASA Centers and laboratories or anywhere scientists, astronauts, and researchers are using cutting-edge aerospace technology. The series is free to registered educational institutions. The live shows and all other NTV programming may be taped for later use.

NTV Weekday Programming Schedules (Eastern Times)

Video File	NASA Gallery	Education File
12–1 p.m.	1–2 p.m.	2–3 p.m.
3–4 p.m.	4–5 p.m.	5–6 p.m.
6–7 p.m.	7–8 p.m.	8–9 p.m.
9–10 p.m.	10–11 p.m.	11–12 p.m.

Live feeds preempt regularly scheduled programming. Check the Internet for program listings at:

<http://www.nasa.gov/ntv/> — NTV Home Page

<http://www.nasa.gov/> — Select “Today at NASA” and “What’s New on NASA TV?”

<http://spacelink.nasa.gov/NASA.News/> — Select “TV Schedules”

Via satellite—GE-2 Satellite, Transponder 9C at 85 degrees West longitude, vertical polarization, with a frequency of 3880.0 megahertz (MHz) and audio of 6.8 MHz—or through collaborating distance learning networks and local cable providers.

For more information on NTV, contact:

NASA TV
NASA Headquarters
Code P-2
Washington, DC 20546-0001
Phone: (202) 358-3572

For more information on the Educational Live Shows, contact:
NASA. . . On the Cutting Edge
NASA Teaching From Space Program
308-A, Watkins CITD Building
Oklahoma State University
Stillwater, OK 74078-8089
E-mail: edge@aesp.nasa.okstate.edu

How to Access NASA’s Education Materials and Services, EP-1998-03-345-HQ

This brochure serves as a guide to accessing a variety of NASA materials and services for educators. Copies are available through the ERC network, or electronically via NASA Spacelink. NASA Spacelink can be accessed at the following address:

<http://spacelink.nasa.gov>

**NASA's Great Observatories
Paper Model
EDUCATOR REPLY CARD**

To achieve America's goals in Educational Excellence, it is NASA's mission to develop supplementary instructional materials and curricula in science, mathematics, and technology. NASA seeks to involve the educational community in the development and improvement of these materials. Your evaluation and suggestions are vital to continually improving NASA educational materials.

Please take a moment to respond to the statements and questions below. You can submit your response through the Internet or by mail. Send your reply to the following Internet address:

http://ehb2.gsfc.nasa.gov/edcats/educational_product

You will then be asked to enter your data at the appropriate prompt.

Otherwise, please return the reply card by mail. Thank you.

1. With what grades did you use the paper model?

Number of Teachers/Faculty:

_____ K-4 _____ 5-8 _____ 9-12 _____ Community College
College/University - _____ Undergraduate _____ Graduate

Number of Students:

_____ K-4 _____ 5-8 _____ 9-12 _____ Community College
College/University - _____ Undergraduate _____ Graduate

Number of Others:

_____ Administrators/Staff _____ Parents _____ Professional Groups
_____ General Public _____ Civic Groups _____ Other

2. What is your home 5- or 9-digit zip code? _____

3. This is a valuable paper model?

Strongly Agree Agree Neutral Disagree Strongly Disagree

4. I expect to apply what I learned in this paper model.

Strongly Agree Agree Neutral Disagree Strongly Disagree

5. What kind of recommendation would you make to someone who asks about this paper model?

Excellent Good Average Poor Very Poor

6. How did you use this paper model?

<input type="checkbox"/> Background Information	<input type="checkbox"/> Critical Thinking Tasks
<input type="checkbox"/> Demonstrate NASA Materials	<input type="checkbox"/> Demonstration
<input type="checkbox"/> Group Discussions	<input type="checkbox"/> Hands-On Activities
<input type="checkbox"/> Integration Into Existing Curricula	<input type="checkbox"/> Interdisciplinary Activity
<input type="checkbox"/> Lecture	<input type="checkbox"/> Science and Mathematics
<input type="checkbox"/> Team Activities	<input type="checkbox"/> Standards Integration

Other: Please specify: _____

7. Where did you learn about this paper model?

NASA Educator Resource Center
 NASA Central Operation of Resources for Educators (CORE)
 Institution/School System
 Fellow Educator
 Workshop/Conference
 Other: Please specify: _____

8. What features of this paper model did you find particularly helpful?

9. How can we make this paper model more effective for you?

10. Additional comments:

Today's Date: _____

Fold along line and tape closed.



Please Place
Stamp Here
Post Office
Will Not Deliver
Without Proper
Postage

**NATIONAL AERONAUTICS AND SPACE ADMINISTRATION
EDUCATION DIVISION
MAIL CODE FE
WASHINGTON DC 20546-0001**



Fold along line and tape closed.

