

LRI Technology Summary and Roadmap for Mass Change Mission, May 2020

1. Executive summary

The GRACE Follow-On mission launched in 2018 includes a Laser Ranging Interferometer (LRI) as a technology demonstration payload intended to prove the viability of laser interferometry for interspacecraft ranging. The LRI measures the same observable as the Microwave Instrument (MWI), but with ~100x better precision. It has tracked continuously for more than 100 days without interruption, has 17 dB margin on the link (stable after 1 year on orbit), and has no consumables limiting its life relative to the GRACE Follow-On prime mission. The LRI is part of a longstanding roadmap for improved satellite-to-satellite tracking, which includes laser interferometry, drag free control, and improved accelerometers. At the Mass Change workshop held in Washington, D.C., on July 30 – Aug 1, 2019, the participants endorsed the LRI as a substitute for an MWI on future missions.

This memo describes the LRI (Section 2), discusses changes for the LRI to act as a primary instrument (Section 3), describes potential mission enhancements (Section 4), and includes some comments on potential small satellite implementations (Section 5). The roadmap discusses necessary technology development for the LRI as a primary instrument to reach TRL6 (Section 6). Technology development for missions after the MCM are discussed in Section 7. The schedule and budget for the roadmap have been excised from this version so that it may be released publically.

The following panel participants and other interested community members contributed to this write-up:

John Conklin	University of Florida
Felipe Guzman	University of Arizona
Bill Klipstein	Jet Propulsion Laboratory/California Institute of Technology
Jennifer Lee	Ball Aerospace
Jim Leitch	Ball Aerospace
Kenji Numata	NASA Goddard Space Flight Center
Shelley Petroy	Ball Aerospace
Bob Spero	Jet Propulsion Laboratory/California Institute of Technology
Brent Ware	Jet Propulsion Laboratory/California Institute of Technology
Guan Yang	NASA Goddard Space Flight Center
Tony Yu	NASA Goddard Space Flight Center

2. The Laser Ranging Interferometer on GRACE Follow-On

Figure 1 Shows the components and architecture of the LRI.

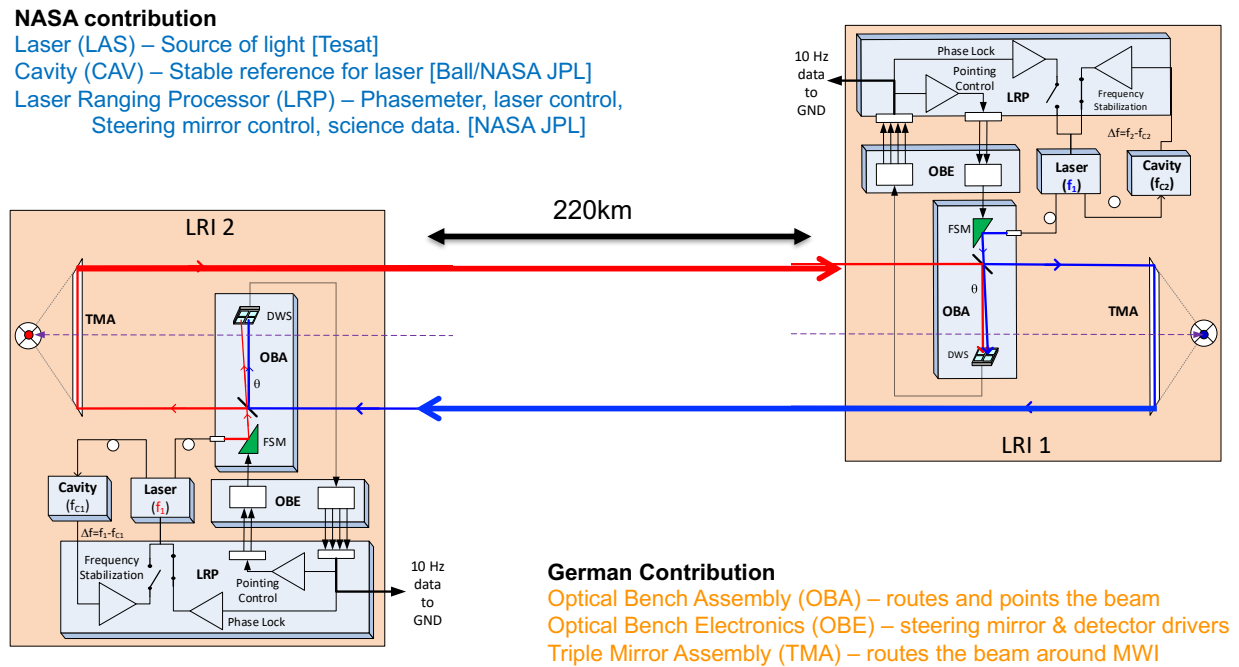

Figure 1 The LRI hardware complement on each spacecraft are identical. The LRI was a joint US-German partnership.

The LRI is comprised of a laser, cavity, laser ranging processor, optical bench assembly, optical bench electronics, and triple mirror assembly. The LRI components weighed 25 kg and consumed 36 W. For details on the operation of LRI, see [Phys Rev. Lett 123, 031101 (2019)]. The LRI sampler uses an output from the same USO driving the MWI (although the effect of clock noise is smaller in the LRI by the ratio of wavelengths, 1 μm optical wavelength vs 1 cm microwave).

The 25 mW infrared laser provides the light source for the interferometer. The laser is stabilized to a thermally stable ultra-low expansion glass cavity to lower the laser frequency noise to an acceptable level. The stabilized laser light is transmitted over a fiber to the optical bench assembly, where the light is transmitted to the other spacecraft, and the light from the other spacecraft interfered with the local laser beam to generate a heterodyne beat note. The phase change of the heterodyne beat note gives the range change between the spacecraft. The beat note is measured by photodiodes on the optical bench, and the electrical signal measured by the optical bench electronics. As the laser beam divergence is smaller than the variation in spacecraft pointing, the differential phase of the quadrant photodiodes is used to control a steering mirror, which continually points the laser beam at the other spacecraft based on changing differential phase.

This electro-optical system is monitored and controlled by the Laser Ranging Processor, which locks the laser to the cavity on the master spacecraft, phase locks the laser on the other spacecraft to maintain the heterodyne beat note, measures the differential phase and controls the pointing, and finally makes the science measurement of the Laser Ranging Instrument. The LRP also controls acquisition of the optical heterodyne signal in spatial alignment and frequency, and reports telemetry to the on-board computer.

The LRI has exceeded its requirements in orbit. Each spacecraft acquired the other spacecraft on first try, and since first light has returned science continuously except when interrupted by spacecraft operations. At one point the LRI had operated continuously for more than 100 days and 1500 orbits, before operations required it to lose lock for a calibration maneuver. When the spacecraft returned to nominal pointing, the LRI autonomously re-acquired and resumed science operations. The LRI, may we say, just wants to be in science. It is remarkably stable.

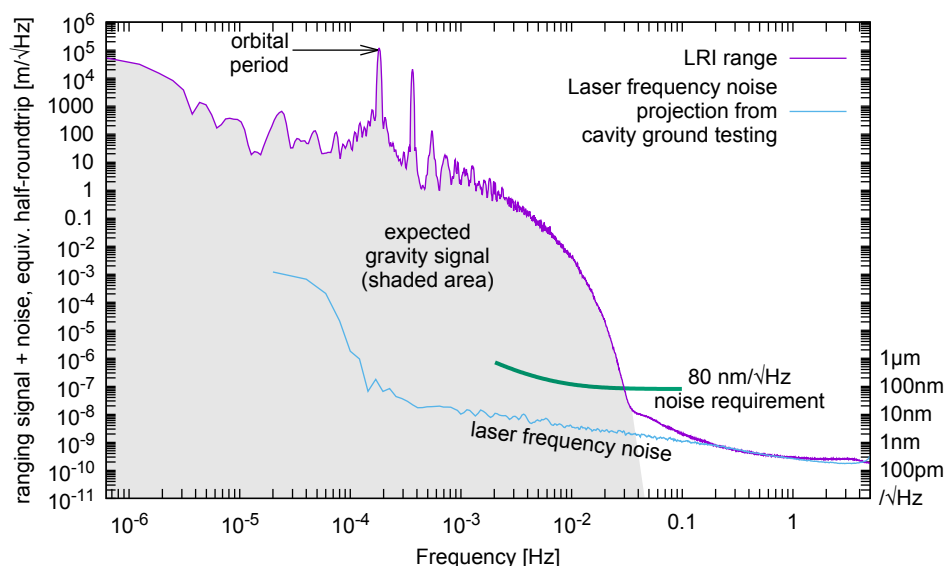

Figure 2. Amplitude spectral density of LRI ranging measurements. The purple line shows the ranging signal, after subtraction of phase jumps, which is dominated by the gravity signal below 30mHz. The blue line shows the stabilized laser frequency noise from ground measurements. The green line shows the LRI requirements.

3. Things that need to change to use LRI as prime instrument

Three issues have been identified as work required to use LRI as the prime instrument on the next MCM:

- a. Lessons learned from LRI,
- b. Redundancy,
- c. Changes in the scale factor over long times (days to months to years).

These are addressed in the following subsections.

a. Lessons learned

As a technology demonstration for this laser ranging instrument, it is perhaps not surprising that there were unexpected effects in the building of the instrument, and in the performance in-orbit. These did not affect the ultimate performance of the instrument, but the lessons learnt should be applied to the next iteration of the mission.

The lessons learnt are two:

- I. As an optical instrument, the methods by which the optics are mechanically bonded, and the stresses induced by the design over time were not fully understood. In the period after instrument delivery but prior to launch the epoxies used to bond some of the glass optical components absorbed moisture from normal humidity, and expanded. This was not foreseen in the stress analysis, and the mechanical stresses caused some of the bonds to fail, or to begin to fail. One cavity had to be removed from the spacecraft and reworked, and there was concern about the triple mirror assembly bonds. In the end, the optical structures have performed admirably well in-orbit. In the future, alternative methods of bonding should be investigated, and mechanical stress analysis performed with these concerns in mind. Keeping the bonded components in vacuum throughout the lengthy I&T process will be considered. Work addressing the optical bonding approach and stability for the optical cavity is being conducted by the Ball Aerospace/JPL team to establish best-practices for optical bonding of cavity optics for future missions. The approach developed from this work can be applied to other critical optical assemblies as well (e.g., the TMA).
- II. Just after launch the team discovered a sensitivity to mechanical disturbances associated with attitude control thruster solenoid actuation. This vibration is transmitted through the spacecraft structure to the laser, which exhibits fast frequency change due to microphonic sensitivity. The phasemeter response to a frequency impulse is well-defined, and the resulting phase jumps can be removed in data processing. A combination of mechanical isolation and modified control laws will ameliorate or completely eliminate the phase jumps in the next version of the LRI.

b. Redundancy options

The LRI is a Class D tech demo, and as such is mostly not redundant (there are redundant photodiodes; the lasers have internal redundancy; and because there is one cavity per spacecraft and only one needs to be used, these are redundant). As a Class C mission, we would analyze the failure mechanisms and design a combination block- and cross-strap redundant system where appropriate. For instance, it would be a substantial change to have a redundant triple mirror assembly, so this might remain single-string. While the optical bench would stay largely the same, the team would investigate using block redundant fiber optic input systems, and redundant steering mirrors. The LRP would be block redundant, and the team would investigate whether laser and cavity control could be cross-strapped. There are no lifetime limiting components in the current mission – the

lasers and steering mirrors have 15 year lifetimes. Most of the electronic components in the LRI were of comparable parts quality to a Class C mission, but this will have to be reviewed across all elements of the design.

c. Scale length

Fluctuations in the wavelength of either the microwave or laser used in the biased range measurement are indistinguishable from actual range changes. In GRACE and GRACE-FO, the microwave signal is an integer multiple of the UltraStable Oscillator (USO), whose frequency is continuously monitored by GPS. In the LRI, the laser wavelength λ controlled by the LRI optical cavity exhibits sub-band changes $\Delta\lambda$ due to ULE spacer aging and temperature sensitivity; this absolute frequency is not monitored on board the spacecraft. The resulting change in measurement scale is $\Delta s = (\Delta\lambda)/\lambda$. Cavities of the type used in LRI have been studied extensively, and the expected fluctuation from cavity aging is on the order of $\Delta s = 10^{-8}$ per year. This is to be compared to the stability requirement of 1 mm Equivalent Water Height, or $0.04\mu\text{gal}$, out of a static gravity anomaly of 100 mgal, or $\Delta s < 4 \cdot 10^{-7}$. The corresponding resolution in Greenland ice is 0.1 gton. It is adequate to measure Δs to this precision a few times per year. Since aging is expected to be smaller than the requirement-level stability, the measurement serves as risk reduction.

Three methods are considered for determining Δs to the required level, which is equivalent to monitoring changes in laser frequency with 100 MHz accuracy.

- I. **High-frequency cavity modulation** Figure 3. The ~ 2 GHz free spectral range (fsr) of the optical cavity is measured by adding phase modulation approximately equal to the fsr and detecting the resulting ~ 100 kHz sidebands in the reflected light. Since the modulation is coherent with a USO that has its frequency precisely monitored by GPS, the fundamental precision of this measurement is better than the required level by orders of magnitude; the limitations to performance are technical only. This method has been tested successfully at JPL under a NASA Center Innovation Fund grant [*ORCLS-Optical-Radio Coherence for Laser Stability, NASA Center Innovation Fund Technical Report, 2017*]. Instrument augmentation required relative to the GRACE-FO LRI: a frequency distribution scheme to generate the high-frequency modulation and demodulation, a bandpass filter, a passive rf mixer for demodulation, and firmware in the FPGA to perform the lock-in amplifier function. Unlike similar modulation methods that have been tested in the laboratory, a separate high-frequency photoreceiver is not required.

The GRAIL mission used a variant of the GRACE measurement hardware to make a gravitational map of Earth's Moon. Lacking GPS, the scale factor was determined by Deep Space Network (DSN) tracking of a RadioScience Beacon (RSB), which was a multiplied version of the USO signal, just as the Ka-band interspacecraft link was. The

RSB signal was ~ 8 GHz, and relied on a programmable frequency source, which we would repurpose for the cavity modulation. The RSB on GRAIL weighted 0.6 kg and consumed 4 W of power; the power was driven in part by the need to transmit from the Moon to Earth.

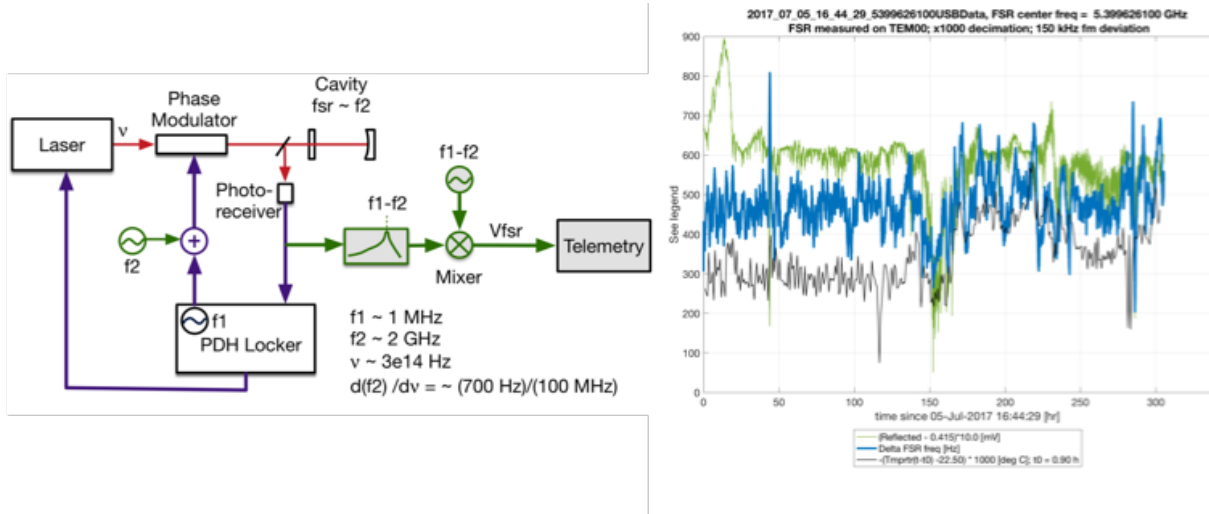

Figure 3 Left: Cavity frequency changes can be measured using additional hardware elements, shown in green. “F2” can be generated by flight hardware from the GRAIL mission, based on the USO input frequency measured by GPS. Right: Experimental results demonstrating viability of the technique.

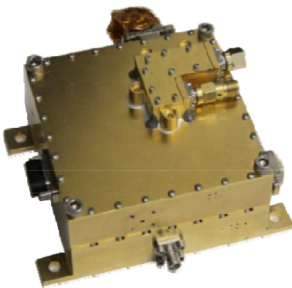

Figure 4 The RadioScience Beacon (RSB), flown on the GRAIL mission to the Moon, will allow calibration of the laser relative to the UltraStable Oscillator that drives the current MWI mission.

II. Frequency comb

Optical frequency combs have revolutionized time and frequency metrology in recent decades, offering a way to translate between frequency stability in the optical domain (tens to hundreds of THz) and the microwave (MHz to GHz) [IEEE J. Sel. Top. Quantum Electron. 9 (4), 1041 (2003), Rev. Mod. Phys. 75 (1), 325 (2003)]. A frequency comb locked to a stable microwave frequency reference like the USO or Rb standard exhibits exceptional stability in its comb “teeth” at optical wavelengths. Conversely, a frequency comb locked to a stable optical reference can be used to derive an ultra-precise microwave frequency.

The frequency comb at its heart is a short-pulsed modelocked laser, which provides a repeating pulsetrain corresponding to a repetition rate f_{rep} (see Figure 6). This provides a set of evenly spaced frequency lines of some finite frequency bandwidth inversely

proportional to the temporal pulsewidth. A frequency comb can be locked in repetition rate f_{rep} to the USO. Furthermore, the modelocked laser spectrum can be amplified and spectrally broadened to an octave or more to access the f-2f self-reference. The f-2f comparison extracts the carrier envelope offset frequency f_{ceo} , which can also be referenced to the USO, which locks down the overall frequency drift of the comb spectrum (see Figure 6, f_0 used to refer to f_{ceo}) [*Phys. Rev. Lett.* 84, 5102 (2000), *Science*, 288, 635 (2000)]. The independent locking of f_{rep} and f_{ceo} , accomplished by tuning of oscillator dynamics (cavity length, pump power, intracavity phase), gives complete tunability and control of individual comb lines. Laboratory demonstrations have shown stability and accuracy metrics of better than 1 part in 10^{14} when locked to an RF reference (Rb clock or GPS) and 1 part in 10^{17} when locked to an optical reference [*IEEE J. Sel. Top. Quantum Electron.* 9 (4), 1041 (2003)].

Menlo systems, along with Humboldt University and Ferdinand-Braun Institute in Berlin, the University Bremen, have flown a comb-based clock in a sounding rocket, demonstrating the technology's viability for space missions [<https://www.menlosystems.com/events/news-press-releases/view/2700> (2018), *Optica* 3, 1381 (2016)]. A group from Korea Advanced Institute of Science and Technology has flown and operated a fiber femtosecond laser (the oscillator for a comb) in low Earth orbit for 1 year [*Sci. Rep.* 4, 5134 (2014)]. In addition, advances in the frequency comb world towards chip-scale combs further open the door to robust, low SWaP, low cost solutions for space.

III. Absolute frequency stabilization – cavity on short time scales, molecular line on time scales > 1 day

The molecular (or atomic) absorption line is a good, drift-free, absolute frequency reference, as represented by optical clocks, because the resonances are determined by the molecule's properties rather than a dimensional artifact. For example, Nd:YAG lasers at 1064 nm can be locked to I_2 (after frequency doubling), ^{132}Cs , CO_2 , C_2H_2 , and C_2HD . Unfortunately, it produces worse laser frequency stability than do optical cavities at a higher Fourier frequency in the MCM science band, because of a limited signal-to-noise ratio, which originates in the number of detectable molecules along the laser beam. Therefore, the LRI instrument would have to carry the two frequency references (the cavity and the molecular gas cell) at the same time, and the two error signals must be merged before feeding back to a laser (Figure 5). This is typically done by frequency-shifting the main laser carrier, either by an acousto-optical frequency shifter [*Optics Communications*, vol. 183, no. 1-4, pp. 165-173, 2000], tunable dual sidebands [*Optics Express*, vol. 16, no. 20, pp. 15980-15990, 2008], tunable cavity length [*Applied Physics B*, vol. 111, no. 2, pp. 223-231, 2013], or a tunable single sideband [*Optics Letters*, vol. 38, no. 12, pp. 2062-2064, (2013)]. The gas cell is a separate component in a simple implementation. Filling the cavity with a reference gas is also possible, as typically done

in cavity-enhanced spectroscopy [*Journal of the Optical Society of America B*, vol. 15, no. 1, pp. 6-15, 1998].

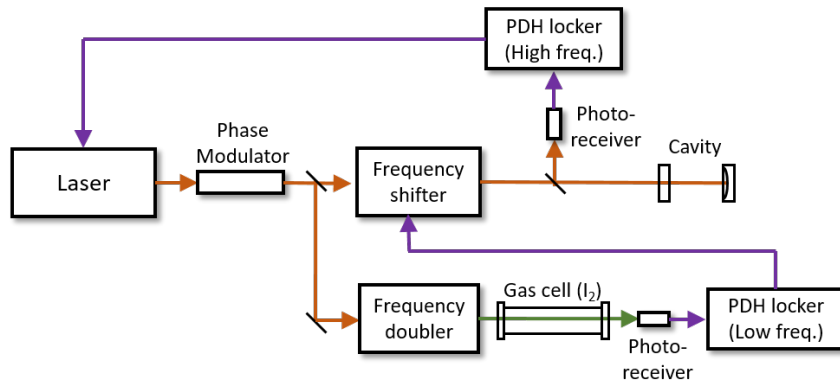

Figure 5 Conceptual diagram of the dual-reference-locked laser at 1064 nm. The laser is locked to both Fabry-Perot cavity at high frequency, and the gas absorption line at low frequency, providing absolute frequency knowledge of the laser.

Alternately, the molecular line could be used to calibrate drifts in the cavity by periodically (e.g. every few months) breaking the cavity lock and measuring the commanded offset to the molecular line. At the level of sensitivity of interest, the measurement should only take a few seconds of integration time on the molecular line; this would be the simplest implementation.

The most successful frequency reference at 1064 nm is I_2 , which has strong absorption lines at the 532 nm region. It has been shown to have 10^{-15} level frequency stability in the 1990s [*IEEE Transactions on Instrumentation and Measurement*, vol. 48, no. 2, pp. 583-586, 1999] and has been used in sub-orbital experiments [*PHYSICAL REVIEW APPLIED*, vol. 11, no. 5, p. 054068, 2019]. Despite the necessity of frequency doubling, it has been used in Doppler-free saturation spectroscopy, which gives kHz-level optical frequency uncertainty at most, as well as frequency stabilizations with Doppler-broadened lines [*Applied Optics*, vol. 32, no. 36, pp. 7382-7386, 1993]. A Doppler-broadened I_2 line (with a width of typically ~ 500 MHz) has been shown to provide ~ 10 MHz absolute frequency uncertainty in a simple single-pass configuration [*Applied Optics*, vol. 49, no. 12, pp. 6264-6267, 2010]. This level of absolute frequency knowledge/stability is sought to be sufficient as a long-term frequency reference in LRI instruments. Compact iodine reference systems have been pursued in various labs and will be ready for the GRACE-II timeframe. The C_2H_2 reference at ~ 1540 nm has also been studied extensively because of telecommunications-related needs and has an advantage of not requiring frequency doubling [*IEEE Transactions on Instrumentation and Measurement*, vol. 48, no. 2, pp. 563-566, 1999]. While Nd:YAG laser at 1064 nm currently provides the best short- and long- term stability, emerging semiconductor laser and photonic integrated circuit technology may allow us to use the new wavelength and telecom components in future LRI instruments.

4. Potential Enhancements to LRI

a. Cavity coating improvements, to improve dominant noise sources

Unless an innovative cancellation technique is invented, the laser frequency stability will continue to set the sensitivity limit of future LRI instruments. The thermal noise (Brownian motion) of reference cavity mirrors imposes a limitation in laser frequency stability [*Physical Review Letters*, vol. 93, no. 25, p. 250602, 2004]. The sensitivity of GRACE-FO LRI is limited by cavity thermal noise at a high Fourier frequency (Figure 2). Various methods have been tried to reduce the effect of cavity thermal noise. These include operating at a cryogenic temperature to freeze the motion [*Optica*, vol. 6, no. 2, pp. 240-243, 2019], making the beam diameter larger to average out the thermal motion [*Applied Physics B*, vol. 113, no. 2, pp. 233-242, 2013], going for a longer cavity length to make the effect fractionally smaller, and using materials with lower mechanical loss to minimize thermal noise power in the Fourier frequency of interest [*Nature Photonics*, vol. 6, pp. 687-692, 2012].

Among various thermal noise reduction attempts, substrate-transferred crystalline coatings [*Nature Photonics*, vol. 7, pp. 644-650, 2013] have been most successful and have been widely used in the field of optical clocks. Instead of sputtered amorphous thin films, typically SiO₂/Ta₂O₅, low-loss single-crystal multilayers of GaAs/AlGaAs grown by molecular beam epitaxy, are selectively removed and then bonded to the optical surface. It provides factor ~3 (~10) improvements in the amplitude (power) spectral density of frequency noise. One drawback of crystalline coatings is that they need to be used with linearly polarized light, whereas traditional optical cavities (including that in GRACE-FO) are often operated with circular polarized light. Therefore, to use crystalline coatings, the optical configuration around the cavity must be revisited.

b. Drag free/Reduced drag operation:

With lower altitudes giving higher sensitivity to the gravity field, there is interest in lowering the altitude of MCM compared to GRACE Follow On. The added atmospheric drag would likely saturate the sensitive accelerometer. One possible approach would be to fly the spacecraft in a reduced drag state by using a controlled continuous thruster to keep the non-inertial forces on the spacecraft within the measurement range of the accelerometer. Thrusters capable of providing the needed forces are being qualified for flight by Enpulsion and ExoTerra Resources and could provide a way to fly the system at a lower altitude. Such thrusters use propellants such as Xe or Indium and require fairly high power (150-200W).

An interesting mission architecture study might take existing thrusters with an existing tank/feed system and determine the altitude that would be support a 12 year mission.

c. Interface between LRI and the accelerometer proof mass

The long-standing vision of a future improved Satellite-satellite tracking (SST) mission involves using laser interferometry with direct readout from an improved proof mass with the spacecraft flown drag free (or at least drag compensated).

Use of the 3 mirror virtual vertex beam reflector enables several possible configurations. It provides a way to range to the center of mass without requiring an optic be located there. It also makes possible several beam reflectors that can point in different directions but share the same virtual vertex. Given an architecture with SST between more spacecraft than just one pair, directions other than the flight direction could be sampled with a different 3 mirror reflector. An alternative system could separate the measurement into an external measurement combined with an internal laser metrology system to get the true distance between the centers of mass of two spacecraft. This could introduce additional error terms unless the system were carefully designed to avoid spacecraft structural changes.

d. Improved accelerometers

The LRI performance has instrument noise below all other system noise except at the highest frequencies. Further improvements to the mission architecture would benefit from an improved accelerometer. Following the successful demonstration of the LISA Pathfinder gravitational reference sensor, a future improved LRI-based mission would benefit from a reduced-performance version of the LISA Gravitational Reference Sensor. Such a sensor could be designed to directly integrate with the LRI, allowing the displacement of the gravitational reference sensor's test mass to be directly measured by the laser interferometer. Interest in that technology is discussed in a different white paper focused on accelerometers.

e. Increased measurement capability for intersatellite ranging

One interesting variation of the Low-Low mission architecture is the use of "pendulum orbits," which sample more cross track effects [*J. Geodesy, vol. 88, pp. 31-43, 2014*]. These orbits involve higher Doppler shifts; one proposed mission architecture for using pendulum orbits involves the use of an optical frequency comb. The basic operational principle of this system (dubbed High-dynamic-range, or HDR GRACE) involves an optical frequency comb and a second narrow-linewidth laser that is locked to the comb. The frequency comb serves as the local oscillator (LO) for the heterodyne detection of the spacecraft-to-spacecraft transmitted probe laser. Instead of a single stabilized laser line of GFO LRI, the frequency comb has a multitude of laser lines, equally spaced in frequency. As the spacecraft-to-spacecraft range changes, the probe laser shifts in frequency due to the Doppler effect, and this frequency shift can be tracked against the multitude of LO frequencies provided by the comb (see Figure 6). As the frequency difference between the shifted probe laser and its nearest comb line is always less than half of the repetition rate of the laser, this greatly relieves the demands on the detection bandwidth of the system. Consequently, larger range changes are within the realm of possibility of such a comb-enabled system (thus the moniker HDR GRACE).

To realize the additional measurement capability of this high dynamic range LRI, one could use a femtosecond laser that is repetition rate locked to a USO and referenced to a stable cavity (much like the LRI cavity). A femtosecond laser at center wavelength 1550 nm with 10 nm bandwidth would provide over 1 THz of "comb teeth" to reference the Doppler shifted

probe laser against. The KAIST femtosecond laser [Sci. Rep. 4, 5134 (2014)] locked to a Rb reference was verified stable to $1\text{E-}12$ over the duration of a 1 year mission life. Furthermore, a single frequency tone within the laser spectrum can be locked to a reference cavity to achieve the wavelength accuracy required for the LRI measurement. The stabilized femtosecond laser is lower SWaP and less complex compared to a fully self-referenced frequency comb [Optica 3, 1381 (2016)], yet can meet the stability requirements for the LRI.

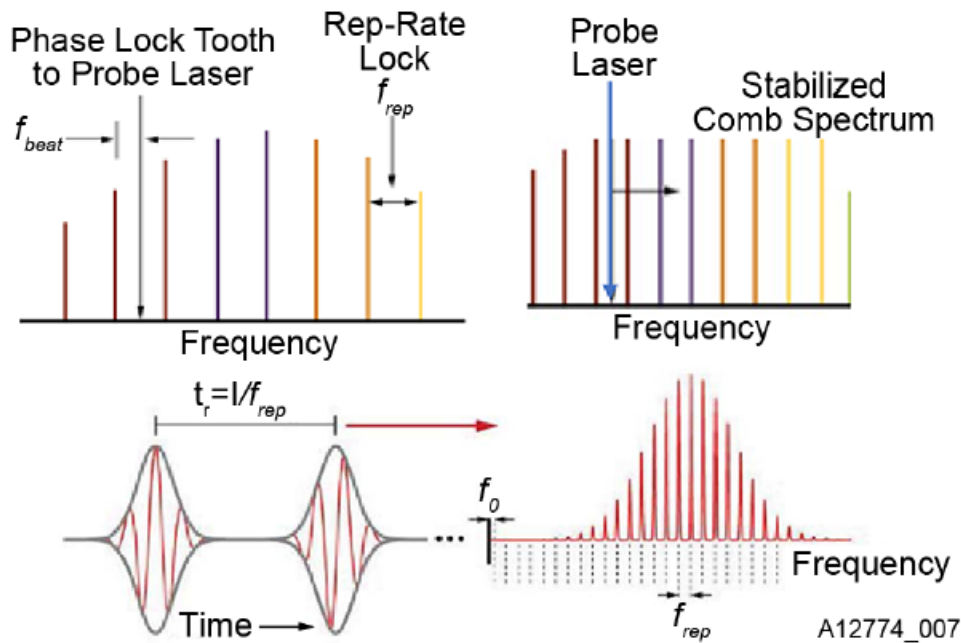

Figure 6. Upper figures: Cartoon showing interaction of a Doppler shifted probe laser against a subset of laser frequency comb lines. Note as the probe laser moves across multiple comb lines, the f_{beat} is always within $f_{rep}/2$ of its nearest comb line. Lower figures: A generalized picture of the time and frequency behavior of a short-pulsed laser, the basis of an optical frequency comb. The pulse temporal spacing t_r , determined by cavity roundtrip time, is inversely proportional to f_{rep} , the repetition rate of the laser (and consequently the comb tooth spacing). f_0 in this figure is also commonly referred to as f_{ceo} (carrier envelope offset frequency) is the overall comb spectrum shift (offset, if you will) from zero. These two frequencies, f_{rep} and f_0 , constitute the two degrees of freedom in a comb spectrum that can be independently locked down.

5. Small-sat/cubesat implementation prospects

In general, small-satellite versions of a low-low satellite pair are presumed to have poorer performance than a replica of GRACE Follow-On, due to a variety of factors. In general, heavier spacecraft will have lower drag accelerations than smaller counterparts, introducing greater impact of drag unless the satellite is flown drag free or drag compensated. Effects at harmonics of the orbit period will in general be worse if the thermal inertia of the spacecraft is compromised by smaller size or lower thermal control capability. Reduced pointing performance will similarly introduce higher stochastic and orbital harmonic errors

in the science data. Reducing SWaP is nevertheless attractive, allowing some mission enhancements, such as technology development payloads and augmentations.

New developments in SmallSat electronics have led to small, rad-tolerant, lower power spacecraft avionics sets. Combined with the conversion of the primary instrument to a laser interferometer, smaller spacecraft are possible for a full capability MCM. Power has driven spacecraft volume in the past, so reduced power demands from spacecraft and payload electronics should lead to smaller required surface area for the body-mounted solar arrays.

a. Smaller NPRO

NASA GSFC is currently developing a laser transmitter for the Laser Interferometer Space Antenna (LISA) mission. The LRI is based on technology development both for Earth Science but also for LISA. We have designed, developed and demonstrated a micro-non-planar ring oscillator (μ NPRO) for the master oscillator for LISA which would be suitable for a MCM. The μ NPRO is based on the NPRO design that is similar to the GRACE-FO laser transmitter from TESAT, but with a smaller sized crystal and higher output power; it is a potential source for LRI in CubeSats or small satellite platforms.

We have successfully completed the μ NPRO Phase 1 development effort (shown in Figure 7 (left)), which yielded four packages for performance evaluation. We have incorporated lessons learned from our Phase 1 effort and continuing our Phase 2 development and packaging of the μ NPRO as seen in Figure 7 (right). Since our MO is intended for low output power with low noise (as a seed laser for the MO), it is possible to use a lower-power pump diode that has single-mode or low-order multimode laser diode. Indeed, the μ NPRO design incorporates two 808 nm single mode pump diodes, each working at >50% de-rating to generate the 120 mW output power. The short round-trip length of the μ NPRO cavity makes the free-spectral-range (FSR) larger, approximately 30 GHz, compared to the 8 GHz of the LRI flight laser. The larger FSR minimizes the coupling from the neighboring longitudinal oscillation mode and makes overlap of the lasers easier to ensure (this was not a limitation with the current LRI lasers). The small size also lowers the overall the thermal volume of the system, thus makes the temperature control of the crystal more robust, maximizing the control bandwidth of the slow loop. The μ NPRO temperature sensitivity is identical to the traditional design ($\sim 3\text{GHz/K}$). More importantly, the μ NPRO can be packaged into a much smaller form factor using micro-optics and telecom packaging techniques such as laser welding. The small size for the μ NPRO allows for easy implementation of full redundancy, even in a CubeSat and small Sat platform where resources are limited. The μ NPRO package has two pump diodes inside, which are simultaneously driven at low injection current, to further extend the lifetime.

The packaged size of the Phase 2 μ NPRO is <70 mm x 45 mm x 35mm which does not include the output fiber port in front of the package. The output power is coupled to a polarization maintaining (PM) fiber with nominal output power ~ 120 mW.

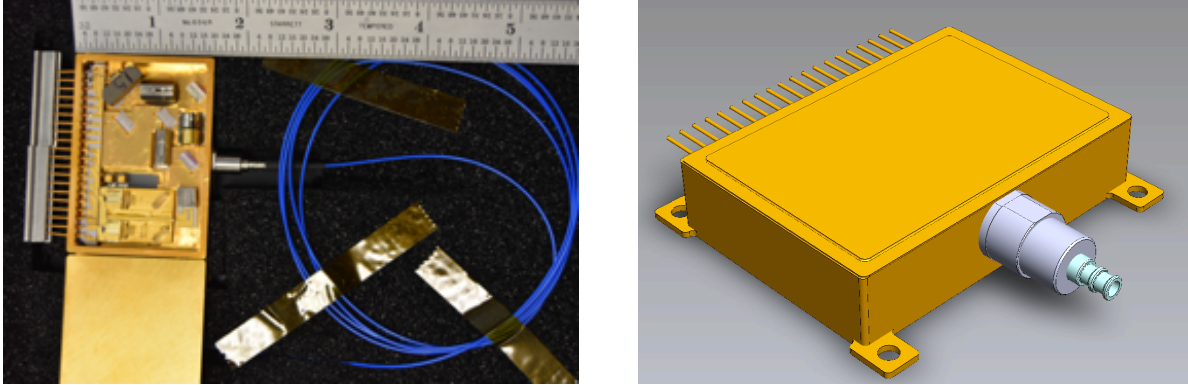

Figure 7. (right) Photo of a Phase 1 μ NPRO with output fiber. (left) Phase 2 μ NPRO CAD model, PM output fiber not shown.

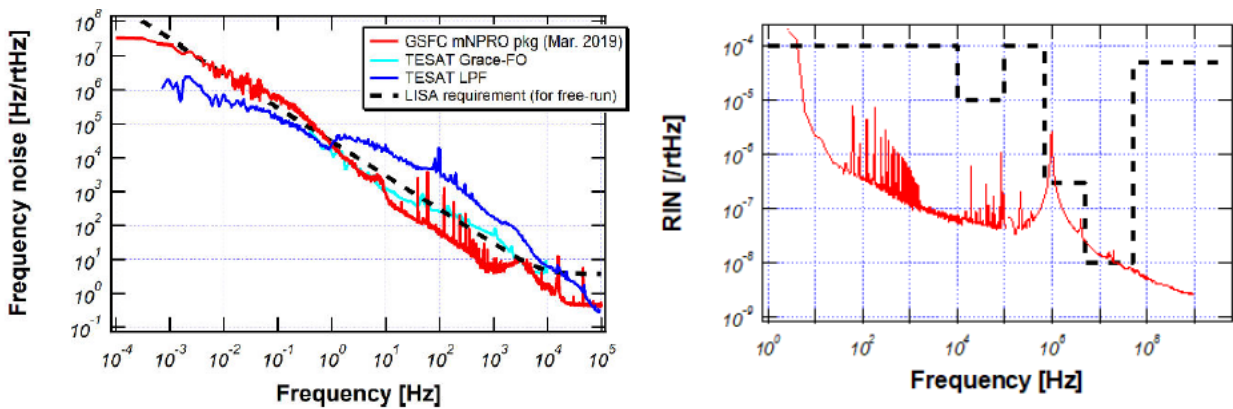

Figure 8. Performance assessment of the Phase 1 μ NPRO laser - (Left) Frequency noise and (Right) Relative Intensity Noise (RIN).

The frequency noise curves of the Phase 1 μ NPRO as compared to the TESAT GFO and LISA PathFinder is shown in Figure 8 (left). The free-running relative intensity noise (RIN) of the μ NPRO laser is shown in Figure 8 (Right) for the Phase 1 prototype of the μ NPRO laser. We also frequency stabilized the laser to a reference cavity to satisfy one of the LISA requirements.

A TRL-6 qualified version of this laser is on schedule to be completed in 4th quarter 2020.

b. Compact Accelerometers

Future mass change missions will likely require accelerometer sensitivities at levels near or below the ONERA instruments that have already been flown on GRACE and GRACE-FO, namely: $10^{-11} - 10^{-10} \text{ m s}^{-2}/\sqrt{\text{Hz}}$. Alternatives like the MicroSTAR or CubSTAR from ONERA and the LISA Pathfinder GRS (or similar) are not likely to be compatible with highly compact spacecraft platforms due to their SWaP characteristics.

Recent advances in optomechanics have expanded the possibilities for developing novel miniaturized accelerometers of extraordinary performance. While conventional MEMS devices do not typically address the sensitivity and observation required for mass change applications, similar micro-fabrication techniques can be used to develop acceleration sensors that approach sensitivities and observation

bandwidths of interest for mass change observations [*Nature*, 531, 614–617, 2016; *Applied Physics Letters*, 104, 2014; *Space Science Reviews* 215:12 (2019); “Optomechanical accelerometers”, *Presentation at the NASA Mass Change Workshop, Washington, DC, July 2019*].

Preliminary measurements and performance estimates of the systems described at the workshop show promising results regarding the achievable acceleration noise floors with highly compact sensors. These devices consist of monolithic oscillators fabricated from a single wafer of low loss materials that can achieve very high mechanical quality factors. These are combined with highly compact laser interferometers (Fabry-Perot and Mach-Zehnder topologies) that are monolithically or quasi-monolithically attached to the mechanical oscillator itself in order to sense the test mass displacement.

Material selections include low loss glass ceramics – such as fused-silica – and crystalline silicon, among others. The materials used to fabricate the mechanical oscillators and the built-in optical components – which constitute the compact test mass sensing interferometers – are inherently compatible with vacuum operations and show low susceptibility to radiation and magnetic effects.

Laboratory prototypes demonstrated displacement sensitivities of the order of $10^{-13} - 10^{-15} \text{ m s}^{-2}/\sqrt{\text{Hz}}$ over measurement frequencies of 2 mHz up to 100 Hz, respectively. Also, micro-fabricated oscillators with natural frequencies around 10 Hz measured mechanical quality factors above 700 and up to a few 1000; indicating acceleration noise floors at levels of $10^{-10} \text{ m s}^{-2}/\sqrt{\text{Hz}}$, and below, within the observation bandwidth of interest. Similar devices of higher frequency demonstrated quality factors up to 4 million in vacuum experiments.

While this technology is currently in early stages of development, possibly at TRL 2, it outlines a path to realize highly compact accelerometers at comparable sensitivities to the systems flown on GRACE and GRACE-FO, with SWaP characteristics compatible with highly compact spacecraft platforms. The total weight of the integrated sensor head, including optical components is approximately 30 grams. A driving unit containing a laser head, fiber circuitry, photodetector and data acquisition electronics requires further development.

Ongoing efforts are focused on unit-level integration and dedicated experiments to characterize the performance of an integrated optomechanical accelerometer unit. Systems engineering developments are also planned for the near future regarding packaging, transportation and field testing. These additional steps will likely yield a TRL 4-5 unit that can be thoroughly assessed for its full-scope feasibility as a flight instrument in future mass change missions onboard compact spacecraft.

c. Active pointing tracking in a small-satellite MCM

In considering MCM using small satellites, one of the workshop participants has investigated using a modified interferometer configuration in which a steering mirror is added in place of the Triple Mirror Assembly, and a CCD camera is added to help with signal acquisition. Further details are available in the presentation from the meeting and in *Guangning Yang and Jeffrey Chen, patent application, “Active Point and Tracking System” 2019.05.16 - GSC-17923-1*.

6. Technology roadmap for LRI as prime for MCM:

To make the LRI ready for the Mass Change Mission, development is needed for the changes listed in section 3:

- Lessons learned from LRI,
- Redundancy,
- Changes in the scale length over long times (days to months to years).

We will also consider the implementation of contributions provided to the GFO LRI by Germany:

- Triple mirror assembly (TMA)
- Optical bench assembly (OBA)
- Optical bench electronics (OBE)

These considerations are intertwined with the interfaces to the spacecraft and a GRS tech demo.

While parts of the Class C LRI will remain at TRL9 (LRP, LAS, OBE), the changes necessary to implement a redundant prime instrument may drop some of the components (OBA, TMA) back to a lower TRL which will require development to reach TRL6. The scale factor solution will have to be developed to TRL6 from its current state.

We will also consider the inclusion of a GRS accelerometer as a technology demonstration, and how that might affect the design of the Prime LRI. GRS technology is being developed in a separate study; in this roadmap, we will consider the LRI interface between both a GRACE FO Onera SuperStar accelerometer and a GRS tech demo accelerometer. Additionally we will analyze the contributions of noise from each instrument.

In this document, the two accelerometers will be distinguished as the heritage GRACE Follow-on Onera SuperStar – ACC; and the technology demonstration gravitational reference sensor - GRS.

In order to prepare for a Mass Change Mission with the LRI as the Class C prime instrument, and with the mandate of no gaps in the GRACE/GFO record, we suggest immediate investment in technology development for the following areas to ensure the success of the Mass Change Mission:

1. Scale length
2. Redundancy options
 - a. TMA
 - b. OBA

- c. OBE
- d. Laser
- 3. GRS tech demo/ACC interface with LRI
- 4. Microphonic sensitivity mitigation of the LRI
- 5. Sensitivity improvements

Some of these tasks are design trades, and/or analysis studies (e.g. redundancy, instrument improvements); others will require experiment and hardware development in order to address TRL (e.g. scale factor, microphonic sensitivity).

a. Scale length

In Section 3.c, several possible solutions to LRI scale length calibration were described. To reach TRL6, we propose a trade study, along with work to develop the requirements.

As the scale length calibration is crucial, we view this activity as essential to proceed to TRL6.

We will study the following technologies:

1. High-frequency cavity modulation
2. Frequency comb
3. Absolute frequency stabilization

1. High frequency cavity modulation

High frequency cavity modulation measures changes in laser absolute frequency based on phase modulation at a multiple of the cavity free-spectral range, and was successfully demonstrated in 2017 (Section 3c). It achieved $\alpha < 1 \cdot 10^{-8}$ over 300 hours. To advance the scale factor measurement to TRL 6 requires two technology developments:

1. TRL 6 phase modulation synchronous with GPS. The phase modulator employed by the LRI will be changed to a modulator with higher bandwidth, at least 2 GHz. The RadioScience Beacon hardware flown on the GRAIL mission to the moon can be used to provide the drive voltage for the modulator.
2. Long-term testing of the free-spectral range of a representative cavity. To verify the readout stability over one year will require a dedicated cavity maintained under vacuum that is stable to better than $\alpha = 3 \cdot 10^{-7}$. The FSR will be measured daily for at least one year. We expect the cost of this to be a COTS vacuum chamber, pump, and cavity, initial setup, and automated monitoring and unattended operations GSE.

This technology is the minimum configuration change to the current LRI, and likely minimum cost and risk option. The concept has been tested experimentally for short durations [ORCLS-Optical-Radio Coherence for Laser Stability, NASA Center Innovation Fund Technical Report, 2017; ANU Space Interferometry Group 2020-01 "Measuring laser frequency stability using a stable oscillator"].

2. Frequency comb

The optical frequency comb provides a method to precisely correlate an optical wavelength to a microwave frequency reference; its accuracy is essentially constrained to the precision of the microwave reference itself (eg. USO, GPS). The proposed task is to perform a measurement demonstration, then specify the design changes/electronics enhancements required to integrate this scale factor measurement with the LRI.

Initial development of measurement technique and proof of concept demonstration experiment are planned under Category 3 funding already allocated to Ball by MCDO for technology development.

3. Absolute frequency stabilization

We will consider absolute frequency stabilization to an atomic line also.

We will also do a long-term test of the free-spectral range (FSR) of a representative cavity. To verify the readout stability over one year will require a dedicated cavity stable to better than $\alpha = 3 \cdot 10^{-7}$ maintained under vacuum. The FSR will be measured daily for at least one year.

Scale length TRL6 plan

1. Determine requirements
2. trade study of potential scale factor solutions (with industry), *e.g.*,
 - a. high frequency cavity stabilization
 - b. frequency comb
 - c. atomic stabilization
3. Set up experiment with option a, b, or c. Assume low-cost option a for baseline.
4. Measure frequency stability of representative cavity in vacuum for 12 months
5. TRL6 development of scale factor solution (not including EM cavity(s) if necessary – see below)
6. Environmental tests (TVAC)

b. TMA

Though working very well in orbit, TMA mirror bonds showed signs of deteriorating during I&T. We will consider lessons learned from GRACE Follow-on cavity studies as they apply to TMA bonds.

One could consider the TMA as structure, as with the GRACE/GRACE-FO MWI horn, or whether it is possible and advantageous to make the TMA redundant. TMA as structure is minimum configuration change from the LRI, and lowest cost option, as the heritage TMA design can be used, modulo changes in bonding the mirrors to the structure.

We propose a trade study to decide whether the TMA should be redundant, with knock-on effects to the OBA and spacecraft.

This effort is essential for an LRI as Prime mission.

As this mission is considering flying both the GRACE FO ACC, and the tech demonstration GRS, the dual interface to these will be studied.

If the GRS tech demo flies in a drag-free configuration, with thrusters in the direction between the spacecraft near the optical baffles, additional study of contamination that did not exist in GRACE FO must be examined.

This effort is envisioned as a joint JPL/industry design study. Some of these tasks may be pursued in parallel, while others depend on the determination whether the TMA is to be redundant or structural.

TMA plan

- non-redundant vs redundant trade study
- bonding improvements study
- interface/vertex for primary and tech demo accelerometers study
 - Redundant TMA
 - Structural TMA

Ball proposed work would extend their recent TMA built for ICESat 2 for use on the MCM. With nearly identical alignment and stability requirements, the design/fab/qual of the MCM TMA can make use of the ICESat 2 approach. There are certain design changes needed to meet the requirements of the TMA for an LRI-type instrument, namely a larger overall size to account for the longer pathlength (TBD spacecraft design). On-orbit performance of the ICESat 2 unit has been excellent.

Initial conceptual studies are planned under Category 3 funding already allocated by MCDO for technology development.

c. Optical Bench System (OBS)

We will consider whether the OBA needs to be completely redundant, or whether parts of it are structural. If the former, there could be two separate OBAs each interfaced to its own laser (and perhaps TMA), or a combination.

This effort is essential to proceed to TRL6. The result of this ranges from using the OBA as is if it's determined to be a structural component, to a complete cold redundant OBA, each interfaced to its own laser.

Like the LRP, presumably the all-electronics OBE will be box-redundant. We will look at the OBA+OBE = OBS as a whole to determine how best to implement redundancy.

Fast steering mirrors (FSMs) suitable for the OBA are in development at Ball, drawing from Ball's extensive flight heritage. One method for accomplishing functional redundancy in the optical bench is to use redundant windings and redundant control electronics for a single FSM. The proposed FSM task would complete an engineering model of the best candidate and conduct environmental tests to qualify it for space use. High reliability/redundancy will be a key consideration.

If a complete OBA is needed for qualification tests and integration of the FSM, another proposed task would build an OBA based on the IRT project hardware and incorporate the FSM for full OBA testing.

Initial conceptual studies are planned under Category 3 funding already allocated by MCDO for technology development.

d. Microphonic sensitivity mitigation

Initial studies of laser microphonic sensitivity to vibrational disturbances on GRACE FO were begun at Airbus using a flight-like thruster and support structure with a flight-like laser. We propose to continue these studies to understand the microphonic acoustic coupling, and methods of mitigation by mechanical design and by altering control systems to reduce sensitivity. We can acquire the thruster testbed from Airbus for further testing at JPL.

This effort is essential to proceed to TRL6.

e. GRS/ACC co-implementation

In GRACE and GRACE FO, considerable effort was made to ensure that the ACC was at the center of mass (COM). The advantage of the LRI TMA was that its virtual vertex could also be located at the COM. However, two accelerometers cannot occupy the same COM. One could consider having them displaced in Z, but at the same X/Y – though this likely makes both non-optimal. It's likely preferable to have the prime accelerometer be at the COM, and account for the displacement of the technology demonstration GRS by other methods.

We propose to study the configuration and interface of the GRS to the LRI and its relationship to the placement of the prime accelerometer. This will guide the performance modeling and requirements estimates of the UFL GRS TRL 6 tech development effort (see Conklin et al. "*Gravitational Reference Sensor Technology Development Roadmap for the Mass Change Mission*").

This collaborative effort will consider the following:

- Analysis of the GRS interface structure to ensure stability at the level of LRI performance - nm/rtHz over the science band
- GRS tilt-to-length coupling analysis and mitigation strategy using a combination of LRI, ACC, GRS and AOCS measurements
- Calibration of the GRS capacitive readout with respect to that of the LRI
- Contamination issues if drag-free thrusters are used on the laser-side of the spacecraft
- Non-bang-bang AOCS and implications for heritage and performance of the ACC.

Some of these studies may be coincident.

f. Improvements to LRI gravity sensitivity

Preliminary analysis of data from GRACE Follow-On indicates that tilt-to-length coupling is the primary limit to ranging sensitivity (Figure 9). Three options will be studied to reduce LRI errors from spacecraft tilt:

- reducing static offsets of the interferometer measurement vertex relative to the spacecraft center of mass,
- refining on-orbit calibration of tilt sensitivity implemented by intentional spacecraft shaking, and
- increasing the interspacecraft baseline. (Figure 10)

Offset reduction will likely require improving the assembly metrology techniques compared to GRACE Follow-On. On-orbit calibration was fortuitously provided by magnetorquer-based shaking for accelerometer center-of-mass offset; dedicated shaking, from magnetorqueres or other angle actuators on MCM will provide more precise calibration. The gravity field sensitivity against tilt-to-length errors is approximately linear with the inter-spacecraft baseline: increasing the baseline from 200 km to 400 km should double sensitivity against both accelerometer noise and tilt-to-length coupling. The signal-to-noise margin demonstrated by the LRI indicates that the laser power and beam divergence will not require modification with a 400 km baseline; this option will be studied by simulations and experiments.

These studies may proceed concurrently.

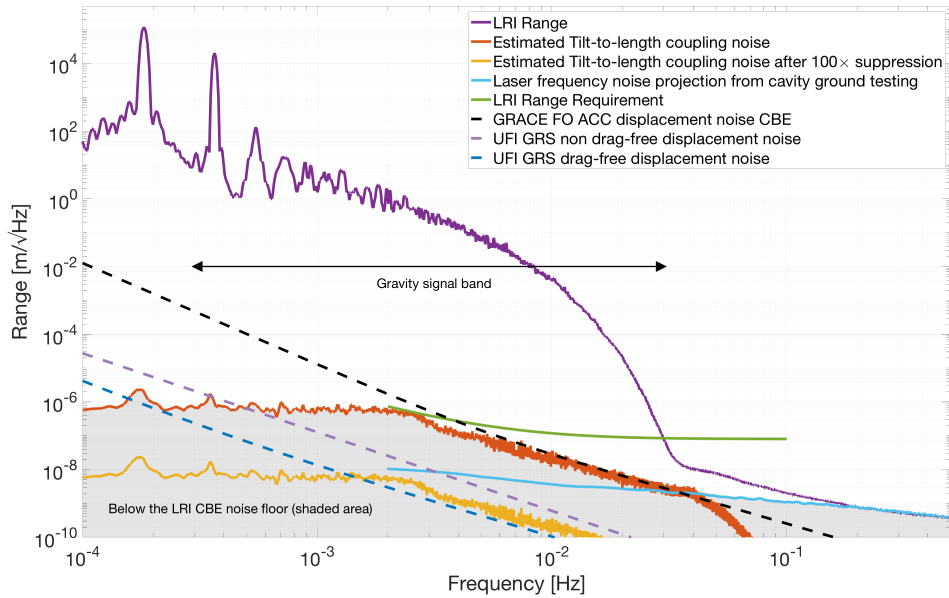

Figure 9. Current best estimate of LRI noise floor compared to GRACE FO ACC, and predicted best case GRS noise for both drag-free and non drag-free implementations. The LRI noise floor is comprised of laser frequency noise at high frequencies and tilt-to-length coupled noise below 40 mHz. Best performance would be achieved if the drag free GRS was used and the LRI tilt-to-length noise was suppressed by a factor of 100.

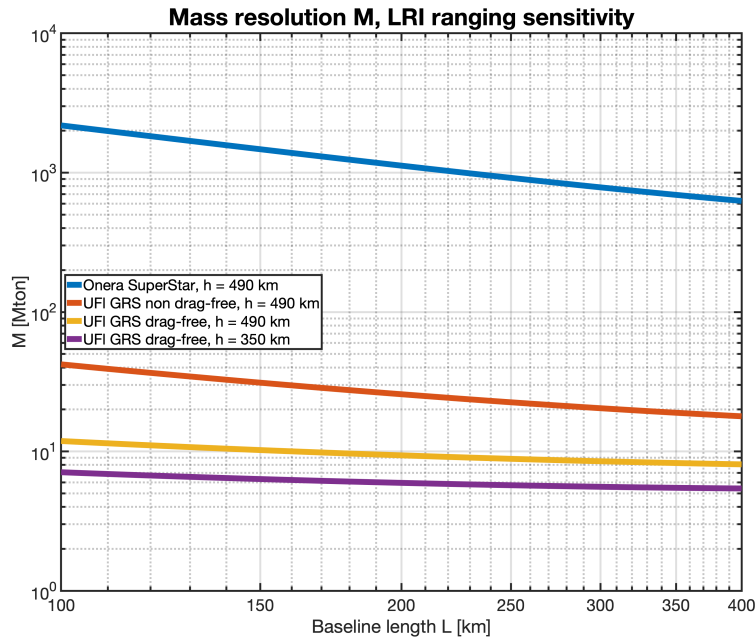

Figure 10. Minimum resolvable mass for MCM as a function of baseline. Blue: Onera SuperStar accelerometer as used on GRACE Follow-On. Red, Yellow, Purple: University of Florida GRS under IIP development. The sensitivity of MCM using SuperStar accelerometers improves close to linearly with baseline, in line with accelerometer-limited sensitivity in general. The much better sensitivity achievable with GRS-based MCM measurements is mostly limited by thermal noise in the laser frequency stabilization cavity; frequency-noise limited measurements have sensitivity only weakly dependent on baseline. This plot shows three options for the GRS: non-drag-free and drag-free at the nominal GRACE FO altitude of 490 km, and drag-free at 350 km. One of the advantages of a drag-free GRS is that it could operate at lower altitude.

g. Cavity assembly improvements

Incorporating lessons learned from GRACE FO, recent bonding and coupling optics work, and the desire to have a vacuum-holding inner vessel, the cavity for MCM makes use of these advancements to step to a 2nd generation cavity assembly having improved coupling stability and robustness.

Further improvements were envisioned as being part of the roadmap for the missions after the MCM. These might include:

- lower thermal noise coatings on cavity mirrors. This could potentially improve the LRI sensitivity by a factor of 3
- form factor – smaller footprint

As in the case of the tilt-to-length coupling noise above, it would be disappointing for the MCM to be limited by laser frequency noise. Initial estimates are that the GRACE FO cavity performance with a factor of three improvement in laser frequency noise would match expected best GRS performance.

Concept development and point design for the vacuum sealed can are planned under Category 3 funding already allocated by MCDO for technology development.

h. Laser

LRI heritage laser

The GRACE FO LRI heritage laser is from Tesat, meets all requirements, and is at TRL9 unchanged. This is the minimum configuration change, and the least expensive option. The MCM would use cold redundant lasers. These would either be combined optically into a single OBA, or each would go to a separate OBA, depending on the result of the OBA redundancy trade study.

The Tesat laser is state of the art, from a German company with whom we have excellent working relations. This configuration would also occur minimal additional I&T costs.

For a GRACE Follow-on-like platform, there is no particular benefit to a smaller, more powerful, laser.

A smaller, higher power NPRO laser, such as the small NPRO under development for LISA, may prove useful for future small-sat missions.

Small NPRO

A TRL 5 small NPRO laser has been built at NASA Goddard under the LISA (Laser Interferometer Space Antenna) program. We propose to continue this work to achieve higher TRL. It should be

able to reach TRL 6 in 2021, and be ready to be considered as a more compact LRI source in the next MCM. Although key component design have been completed, additional work is required in order to fully space-qualify the laser and its electronics. The high output power (maximum 300mW) allows optimization of interferometer parameters, such as a larger beam divergence and longer baseline. Below is the funding level to complete the TRL 6 activities. While the environmental tests only last for 2 mos max, we will keep the lifetest going for as long as possible.

- Complete TRL 6 laser optics design & build
- Complete TRL 6 laser electronics design & build
- Life and environmental tests to qualify for TRL 6, assuming we will keep the lifetest going for as long as possible. The environmental only last for 2 mos max.
- GSE support
- Qualification of other components (e.g. switch)

This development is based on the assumption that the specifications of the laser would not change from that being developed for LISA.

7. Mission(s) after MCM

While considering technology development for the LRI as Prime instrument for the next Mass Change Mission, there are some that might be promising, but could not be at TRL6 in time for the next mission. If these are to be advanced for future missions, development should be considered.

a. Compact ACC

Future mass change missions will require accelerometer sensitivities at levels near or below the ONERA instruments that have flown on GRACE and GRACE-FO: 10^{-11} – 10^{-10} $\text{ms}^{-2}/\text{VHz}$. These large missions run at very high costs, therefore limiting the ability to increase spatial-temporal resolution in mass change observations due to the limited number of pairs that can be launched. Risks of malfunction or critical failure in two-spacecraft missions may impact the data continuity of these observations. Hence, there is interest in investigating alternative mission concepts based on highly compact and cost-effective platforms, such as CubeSats that will address both cost and, primarily, the continuity of observations, also providing a path for launching missions with several satellite pairs. To this end, inertial sensing technologies require further development to reduce their size, weight and power (SWaP) consumption while providing similar sensitivities and compatibility with such small platforms. Current instruments like the MicroSTAR or CubSTAR from ONERA and the LISA Pathfinder GRS (or similar) are not compatible with CubeSats due to their SWaP characteristics.

Recent advances in optomechanics have expanded the possibilities for developing novel miniaturized accelerometers of extraordinary performance. Conventional MEMS devices do not typically address – nor are they capable of reaching – the sensitivities and observation

bandwidths required for mass change applications. However, similar micro-fabrication techniques can be used to develop acceleration sensors that approach sensitivities and observation bandwidths of interest for mass change observations [1-4], with sensitivity levels from $10^{-7} \text{ m s}^{-2}/\sqrt{\text{Hz}}$ to possibly below $10^{-10} \text{ m s}^{-2}/\sqrt{\text{Hz}}$, respectively.

The Laboratory of Space Systems and Optomechanics (LASSO – PI F. Guzman) at the University of Arizona is developing monolithic optomechanical acceleration sensors targeted for high sensitivities at low frequencies. They have conducted preliminary measurements and performance estimates of the systems described in [4] and have shown promising results regarding the achievable acceleration noise floors with highly compact sensors. Recent results revealed very low mechanical losses (mechanical quality factors, Q , above 120,000) with resonance frequencies as low as 3 Hz, indicating achievable acceleration noise floors at levels of $4 \times 10^{-11} \text{ m s}^{-2}/\sqrt{\text{Hz}}$.

These devices consist of monolithic mechanical oscillators fabricated from a single wafer of low loss materials that can achieve very high mechanical quality factors. These are combined with highly compact laser interferometers (Fabry-Perot and Mach-Zehnder topologies) that are monolithically or quasi-monolithically attached to the mechanical oscillator itself in order to sense the test mass displacement. The materials selected exhibit typically very low coefficients of thermal expansion (CTE), around 10^{-7} K^{-1} . The design of mechanical oscillators and laser interferometer topologies is conducted such that the impact of thermal effects and temperature fluctuations can be minimal. Laboratory optical sensor prototypes have demonstrated displacement sensitivities of the order of $10^{-13} - 10^{-15} \text{ m}/\sqrt{\text{Hz}}$ over measurement frequencies of 2 mHz up to 100 Hz, respectively. Also, we have conducted measurements on micro-fabricated oscillators with natural frequencies below 10 Hz, demonstrating mechanical quality factors above 120,000; indicating acceleration noise floors at levels below $10^{-10} \text{ m s}^{-2}/\sqrt{\text{Hz}}$, within the observation bandwidth of interest for mass change.

The following figure shows our current acceleration sensitivity models for these devices and their required test mass displacement resolution to achieve this noise floor.

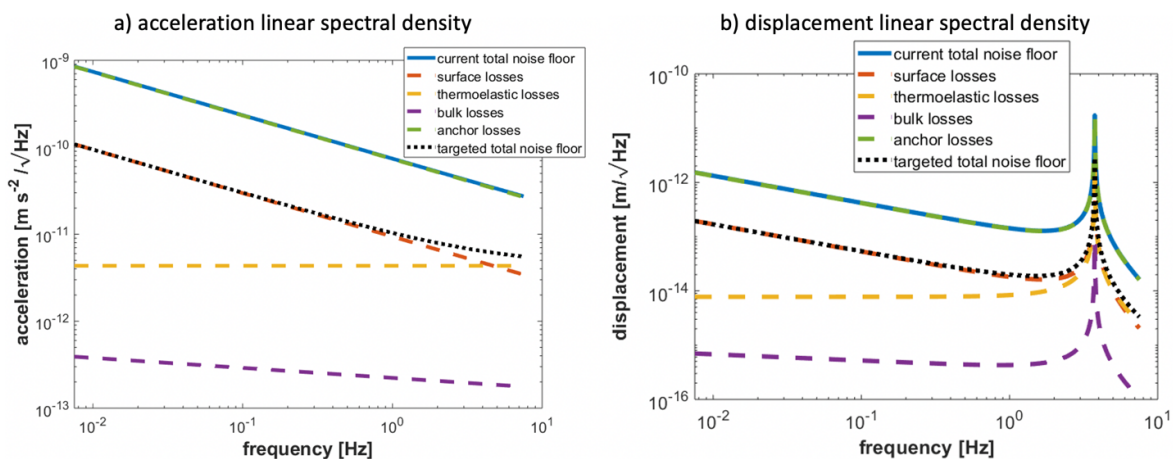

Figure 11. Modeled acceleration and displacement linear spectral densities for low frequency optomechanical accelerometers. a) This plot shows the contribution of individual loss mechanisms to the total acceleration noise floor. b) This trace shows the test mass displacement corresponding to the acceleration noise floor, which determines the required sensitivity of the the displacement sensor measuring the optomechanical test mass dynamics. The solid blue lines mark our current best estimate of

the accelerometer performance we have in the laboratory at with a Q of 120,000. The dotted black lines mark our targeted performance by reducing anchor losses in the sensor packaging/mounts.

This technology is currently in the early stages of development (TRL 2 – 3) as laboratory prototypes. We are currently in the process of launching activities to advance its TRL, aiming a unit at level 4 in approximately 2-3 years, and paving the way towards an instrument that can be flown as technology demonstrator in a future geodesy mission. We estimate that a TRL-6 system can likely be developed in approximately 4-5 years at a cost of approximately \$4M, considering environmental and qualification tests of a packaged sensor head and corresponding driving and data processing electronics. We anticipate conducting the following development steps to realize a TRL-6 system:

- Advance technology to TRL-4 – in part supported by Category 3 technology development grant.
- Development and performance tests for TRL-5 – subunit split in sensor head, opto-electronics subunit and harness
- Development and performance testing for TRL-6 system and subunits, as well as GSE equipment
- Life and environmental tests to qualify for TRL-6.

The LASSO group at the University of Arizona conducts research and development work on compact and highly sensitive displacement interferometry systems that can be valuable to future MCM, including development and testing of laser interferometry concepts, design and assembly of compact optical benches, associated laser and interferometric subsystems such lock-in detection and control schemes, and low-noise photodetectors. Collaboration opportunities with national and international partners on these topics are welcome and possible. LASSO has a long-standing and close collaboration with DLR and AEI in Germany on these areas.

b. Comb for high dynamic range LRI

The use of a frequency comb in a LRI enables measurement of larger range changes (high dynamic range), opening the door to orbit configurations other than the in-line pair – for example, a pendulum orbit. The proposed work would bring this measurement system to TRL 6 with the following steps:

- Measurement demonstration
- Evaluation of noise performance
- Instrument design/LRI enhancements
- EM unit build
- Environmental test

Some initial development (theoretical evaluation of noise performance, proof of concept experiment) is planned under Category 3 funding already allocated by MCDO.

8. Schedule and Budget

Schedules and budget have been estimated, but are regarded as sensitive material and not available for general release.

Additional References: NOT INCORPORATED CORRECTLY IN CURRENT DRAFT

- Amairi, S., Legero, T., Kessler, T., Sterr, U., Wübbena, J. B., Mandel, O., & Schmidt, P. O. (2013). Reducing the effect of thermal noise in optical cavities. *Applied Physics B*, *113*(2), 233-242.
- Arie, A., & Byer, R. L. (1993). Frequency stabilization of the 1064-nm Nd:YAG lasers to Doppler-broadened lines of iodine. *Applied Optics*, *32*(36), 7382-7386.
- Arie, A., & Inbar, E. (1995). Laser spectroscopy of molecular cesium near 1064 nm enhanced by a Fabry–Perot cavity. *Optics Letters*, *20*(1), 88-90. Retrieved from <http://www.advaluephotonics.com/products/1-um-pulsed-single-frequency-fiber-lasers>
- Burkart, J., Daniele, R., & Samir, K. (2013). Optical feedback stabilized laser tuned by single-sideband modulation. *Optics Letters*, *38*(12), 2062-2064.
- Cole, G. D., Zhang, W., Martin, M. J., Ye, J., & AspelMeyer, M. (2013). Tenfold reduction of Brownian noise in high-reflectivity optical coatings. *Nature Photonics*, *7*, 644-650.
- Döringshoff, K., Gutsch, F. B., Schkolnik, V., Kürbis, C., Oswald, M., Pröbster, B., . . . Krut. (2019). Iodine Frequency Reference on a Sounding Rocket. *PHYSICAL REVIEW APPLIED*, *11*(5), 054068.
- Fritschel, P., & Weiss, R. (1992). Frequency match of the Nd:YAG laser at 1.064 μm with a line in CO₂. *Applied Optics*, *31*(12), 1910-1912.
- John, H. L., Ma, L.-S., Taubman, M. S., Tiemann, B. G., Hong, F.-L., Pfister, O., & Ye, J. (1999). Stabilization and frequency measurement of the I₂-stabilized Nd:YAG laser. *IEEE Transactions on Instrumentation and Measurement*, *48*(2), 583-586.
- Kessler, T., Hagemann, C., Grebing, C., Legero, T., Riehle, F., Martin, J. M., . . . Ye, J. (2012). A sub-40-mHz-linewidth laser based on a silicon single-crystal optical cavity. *Nature Photonics*, *6*, 687-692.
- Kokuyama, W., Numata, K., & Camp, J. (2010). Simple iodine reference at 1064 nm for absolute laser frequency determination in space applications. *Applied Optics*, *49*(12), 6264-6267.
- Möhle, K., Kovalchuk, E. V., Döringshoff, K., Nagel, M., & Peters, A. (2013). Highly stable piezoelectrically tunable optical cavities. *Applied Physics B*, *111*(2), 223-231.
- Musha, M., Kanaya, T., Nakagawa, K., & Ueda, K.-i. (2000). The short- and long-term frequency stabilization of an injection-locked Nd:YAG laser in reference to a Fabry–Perot cavity and an iodine saturated absorption line. *Optics Communications*, *183*(1-4), 165-173.
- Nakagawa, K. I., Katsuda, K., Shelkovnikov, A. S., Labachellerie, M. d., & Ohtsu, M. (1994). Highly sensitive detection of molecular absorption using a high finesse optical cavity. *Optics Communications*, *107*(5-6), 369-372.

- Numata, K., Kemery, A., & Camp, J. (2004). Thermal-Noise Limit in the Frequency Stabilization of Lasers with Rigid Cavities. *Physical Review Letters*, *93*(25), 250602.
- Onae, A., Okumura, K., Yoda, J., Nakagawa, K., Yamaguchi, A., Kourogi, M., . . . Widiyatomo, B. (1999). Toward an accurate frequency standard at 1.5 μm based on the acetylene overtone band transition. *IEEE Transactions on Instrumentation and Measurement*, *48*(2), 563-566.
- Robinson, J. M., Oelker, E., Milner, W. R., Zhang, W., Legero, T., Matei, D. G., . . . Ye, J. (2019). Crystalline optical cavity at 4 K with thermal-noise-limited instability and ultralow drift. *Optica*, *6*(2), 240-243.
- Thorpe, J. I., Numata, K., & Livas, J. (2008). Laser frequency stabilization and control through offset sideband locking to optical cavities. *Optics Express*, *16*(20), 15980-15990.
- Ye, J., Ma, L.-S., & Hall, J. L. (1996). Sub-Doppler optical frequency reference at 1.064 μm by means of ultrasensitive cavity-enhanced frequency modulation spectroscopy of a C₂H₂ overtone transition. *Optics Letters*, *21*(13), 1000-1002.
- Ye, J., Ma, L.-S., & Hall, J. L. (1998). Ultrasensitive detections in atomic and molecular physics: demonstration in molecular overtone spectroscopy. *Journal of the Optical Society of America B*, *15*(1), 6-15.