

Uniquely Capturing the Earth in Motion

NASA-ISRO SAR Mission

SNWG Capabilities and Gaps

Paul Rosen

Jet Propulsion Laboratory
California Institute of Technology
NISAR Project Scientist
SDC Architecture Study Lead

Copyright 2020 California Institute of Technology. Government sponsorship acknowledged. Pre-decisional. For discussion purposes only.

Key Scientific Objectives

- Understand the response of ice sheets and glaciers to climate change and the interaction of sea ice and climate
- Understand the dynamics of carbon storage and uptake in wooded, agricultural, wetland, and permafrost systems
- Improve knowledge for forecasts of earthquakes, volcanic eruptions, and landslides

Key Applications Objectives

- Understand societal impacts of dynamics of water, hydrocarbon, and sequestered CO₂ reservoirs
- Enhance agricultural monitoring capability in support of food security objectives
- Apply NISAR's unique data sets to explore the potentials for urgent response and hazard mitigation



NISAR Characteristic:	Would Enable:
L-band (24 cm wavelength)	Low temporal decorrelation and foliage penetration
S-band (9.4 cm wavelength)	Sensitivity to light vegetation
SweepSAR technique with Imaging Swath > 240 km	Global data collection
Polarimetry (Single/Dual/Quad)	Surface characterization and biomass estimation
12-day exact repeat	Rapid Sampling
3 – 10 meters mode-dependent SAR resolution	Small-scale observations
3 yrs (NASA) / 5 yrs (ISRO) science operations	Time-series analysis
Pointing control < 273 arcseconds	Deformation interferometry
Orbit control < 500 meters	Deformation interferometry
> 10% (S) / 50% (L) observation duty cycle	Complete land/ice coverage
Left-only pointing (Left/Right capability)	Uninterrupted time-series Rely on Sentinel-1 for Arctic

NISAR Will Uniquely Capture the Earth in Motion

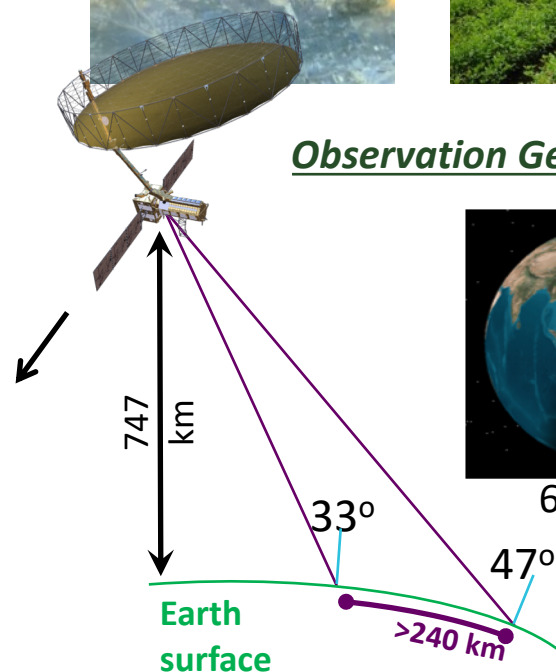
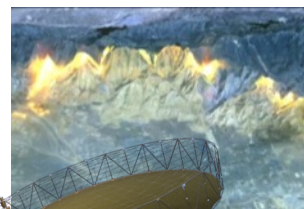

Observation Geometry

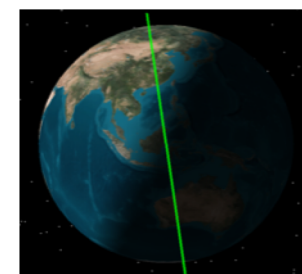

6 AM / 6 PM

- Observation plan
 - NASA Project Science has worked with ISRO and the Mission Systems team for many years to define a comprehensive observation plan to meet the science requirements and harmonize the diverse needs of the many science disciplines
 - The goal is to minimize changes over the life of the mission to generate dense time series
 - Joint Science Team and Mission Systems have agreed to a 6 month update cycle beginning in FY20
 - Address any new ideas from the recently selected Science Team
 - Practice the workflow for updates between Science Team and Mission Systems team.
- L0-L2 Products and ATBDs
 - NASA Project Science Team and Mission Systems Algorithm Development Team have worked closely in defining and refining the product specifications, coordinated with NASA and ISRO Science Teams

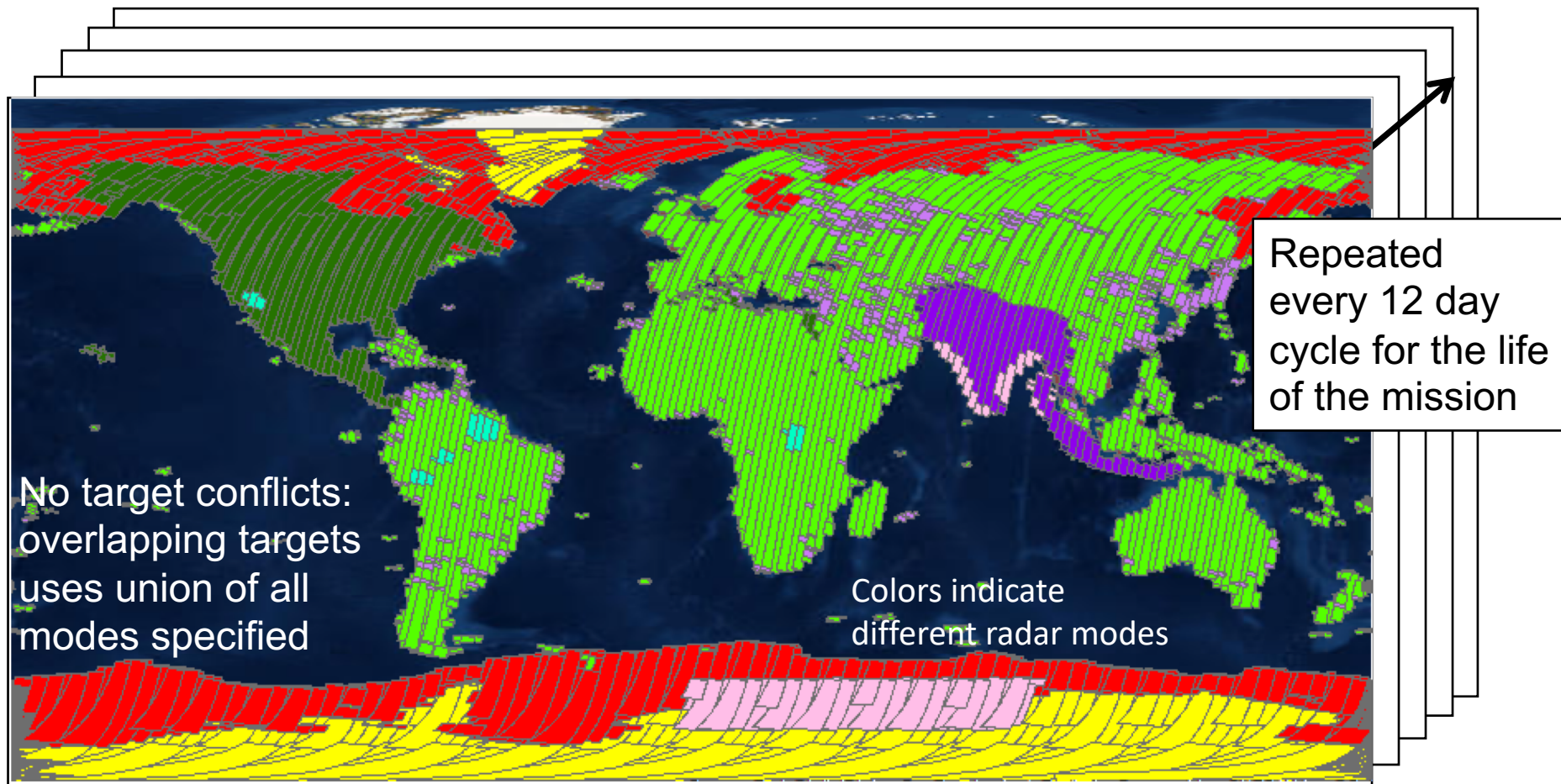

J. Doubleday
P. Sharma, JPL

Persistent updated measurements of Earth 1.6 PB raw data per year
Level-2 global products

Cycle 000

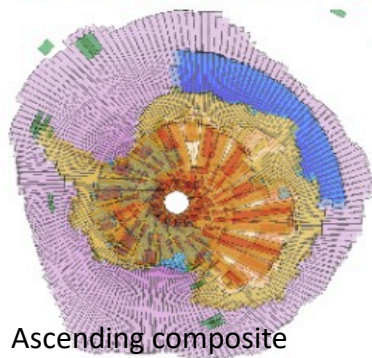
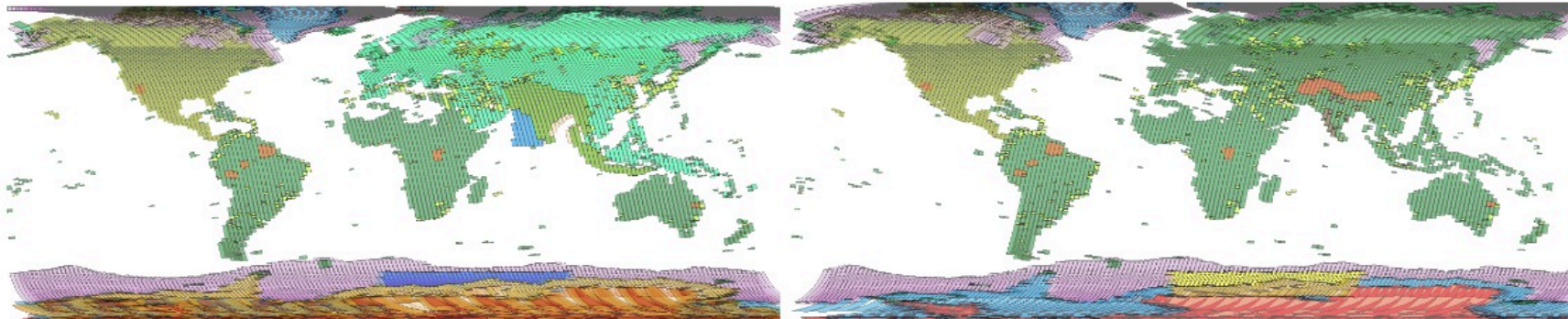

Ascending composite

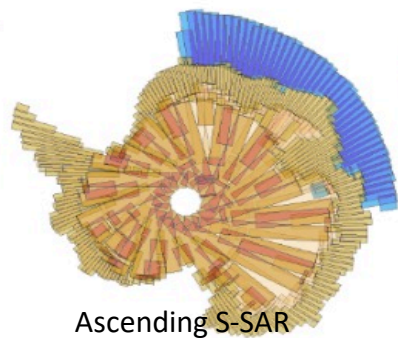

Ascending S-SAR

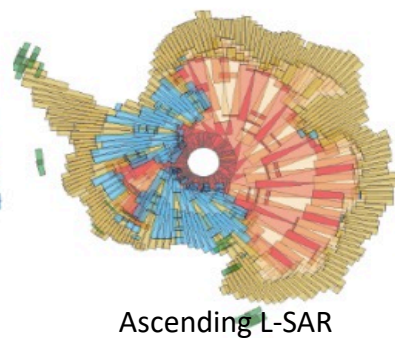

Ascending L-SAR

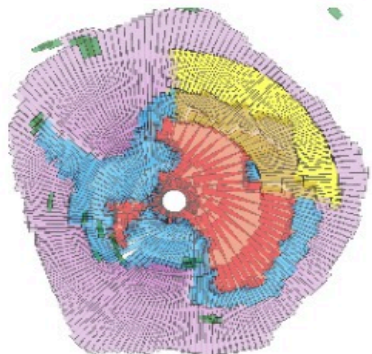

Descending composite

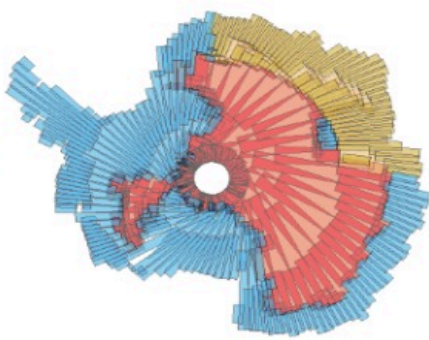

Descending L-SAR

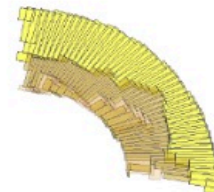

Descending S-SAR

N.America is covered ascending and descending (drk-yellow)
Plan 337: L-SAR QQP 40+5

- Non-EU urban areas are observed (lt-yellow) at L-SAR 40+5 DP
- Current plans have significant work done in Antarctica to collect an ISRO S-SAR mosaic every cycle and to lower L-SAR Data Volume using lower-rate full-swath modes as compared to previous plans (e.g. 325)
- Plan to update plan every 6 months

Mission System Architecture

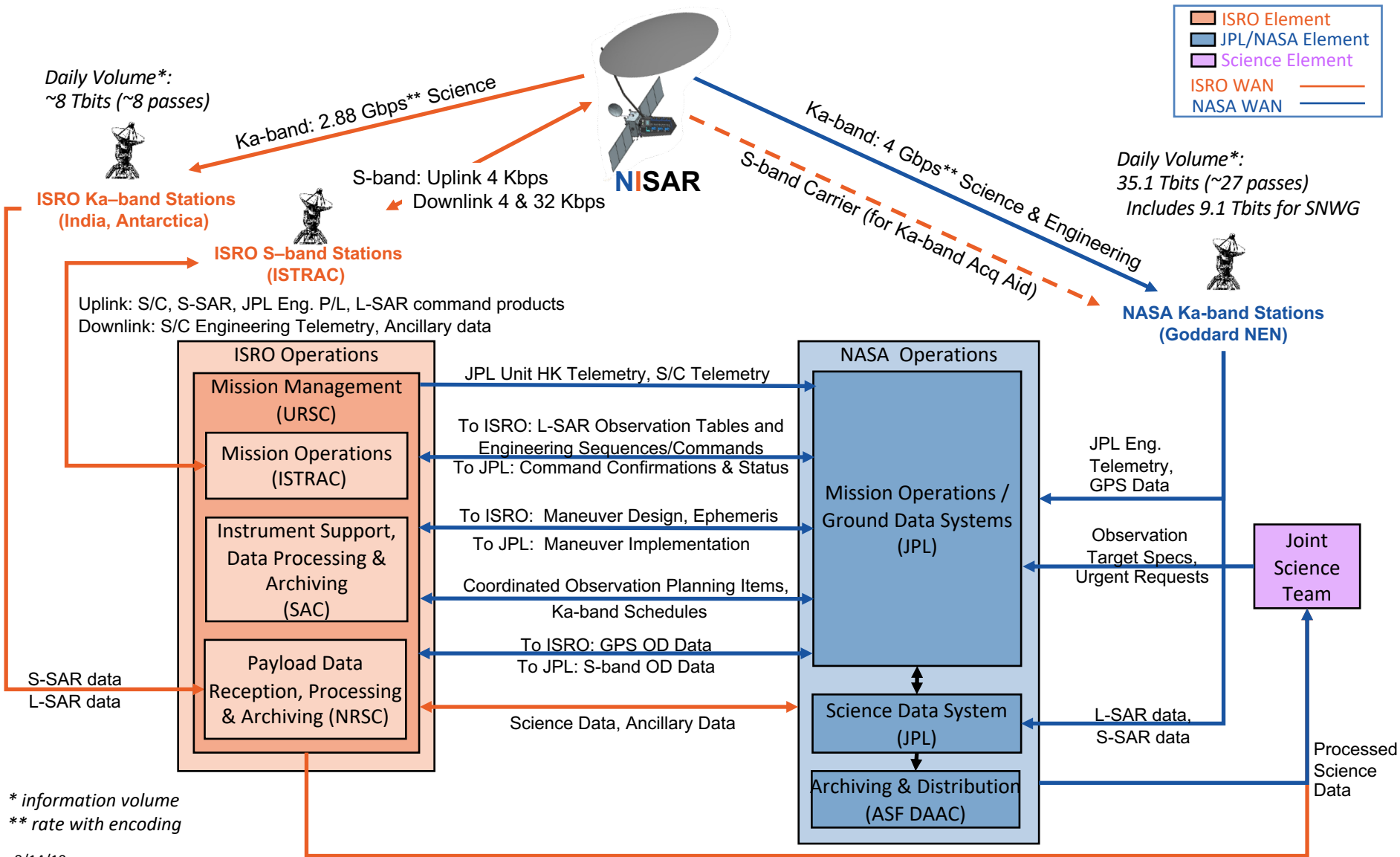

* information volume
 ** rate with encoding

- Ingest 35 Tbits (4.4 TB) of raw data per day on average
- Automatically generate L-SAR L0a, L0b, L1, and L2 science products (> 70TB/day)
 - Generate S-SAR L0 science product for data downlinked through NASA Ka-band
- Perform bulk reprocessing twice during mission
 - 8 months of data after L2 product validation at 4x rate
 - 12 months of data at end of mission at 3x rate
 - Anticipate assessing additional processing / reprocessing options before launch
- SDS makes data available to NASA/ISRO project users and DAAC

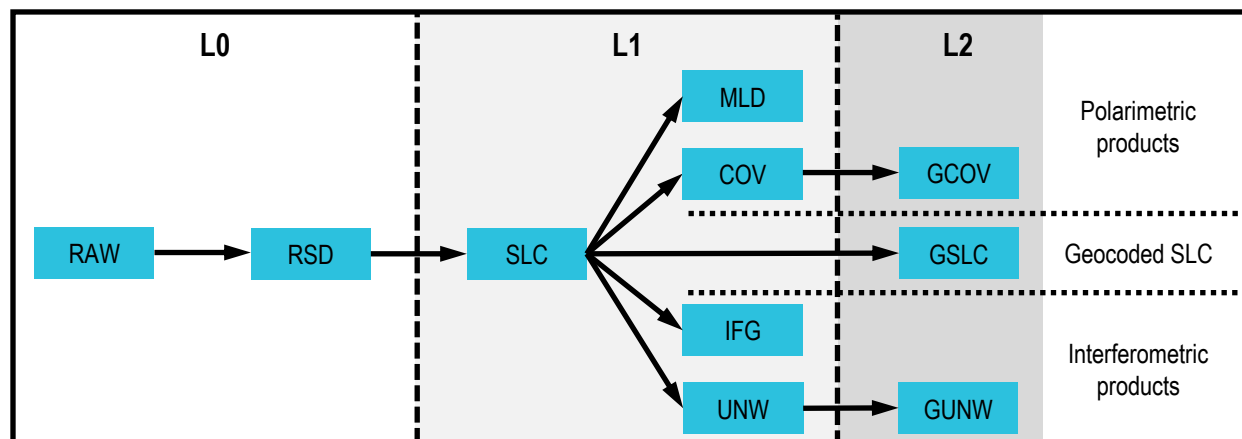

Water: VV

Soil: HH & VV



Sacramento Delta / false color UAVSAR POL-SAR image / 7 m resolution

Vegetation: HV

Red = HH, Blue = VV, Green = HV
(HH => Horizontal Transmit, Horizontal Receive)

Saturated Soil: HH + VV -> VV

Polarimetric SAR

Use of polarization to determine surface properties

Applications:

- Flood extent (w/ & w/o vegetation)
- Land loss/gain
- Coastal bathymetry
- Biomass
- Vegetation type, status
- Pollution & pollution impact (water, coastal land)
- Water flow in some deltaic islands

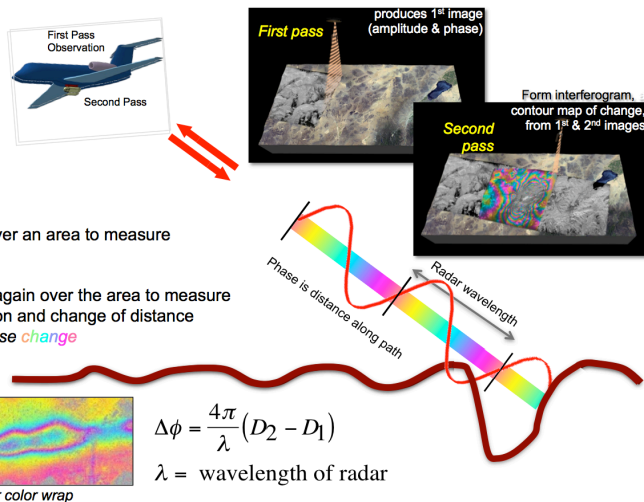

Interferometric SAR

Use of phase change to determine surface displacement

Applications:

- Geophysical modeling
- Subsidence due to fluid withdrawal
- Inundation (w/vegetation)
- Change in flood extent
- Water flow through wetlands

Inundation at Nalsarovar Wetland

11Jun2017

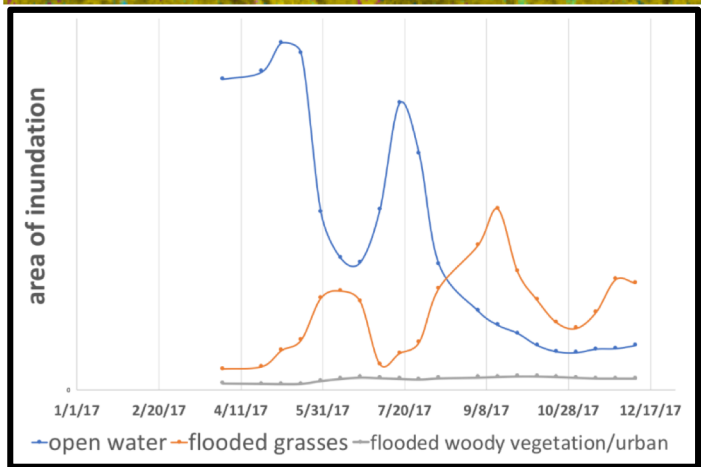
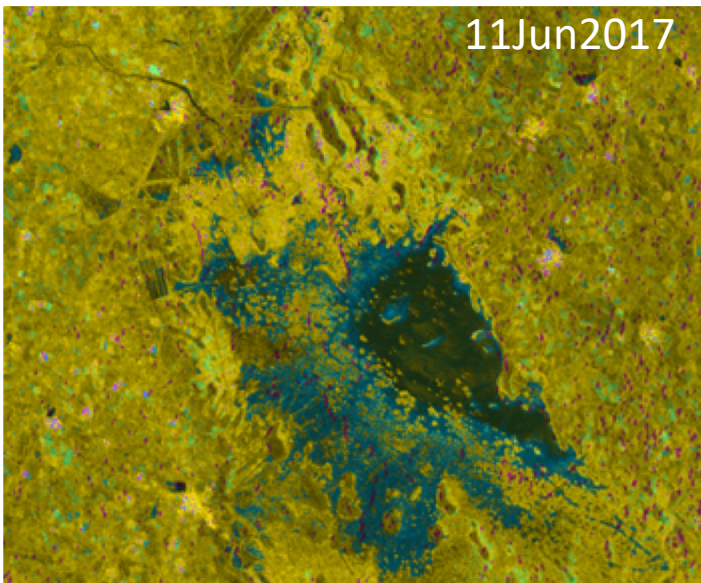

B.Chapman (JPL), TVR Murty, A. Das (ISRO)

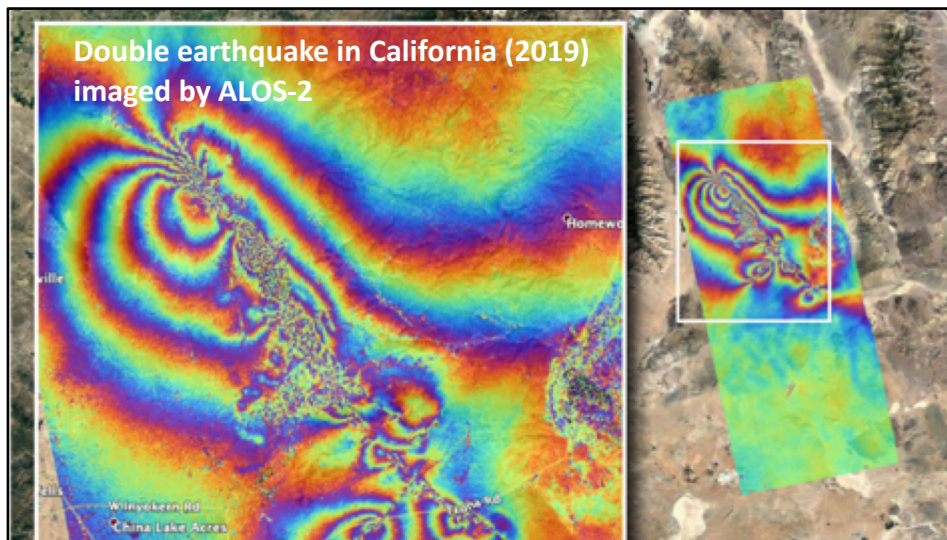

With NISAR, weekly events around the globe for earthquakes, floods, eruptions...

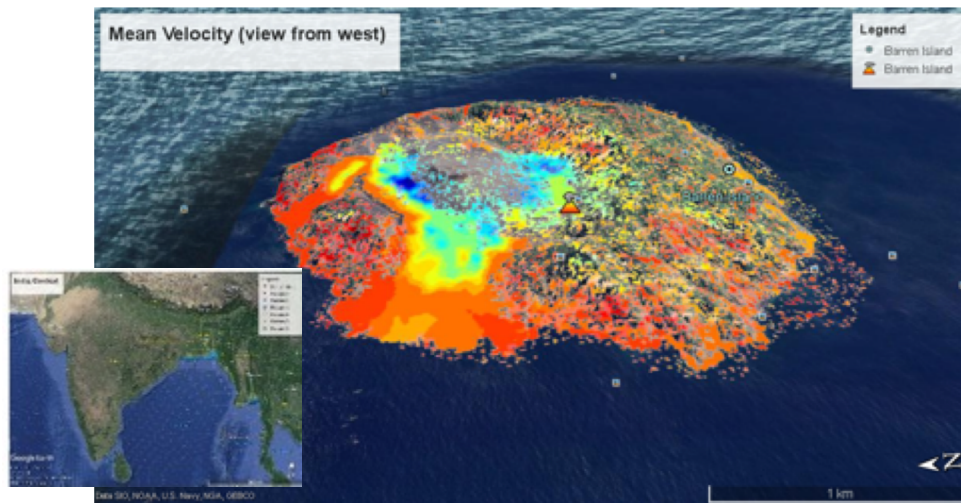

K. Sreejith, R. Agarwal (ISRO) and P. Agram (JPL)

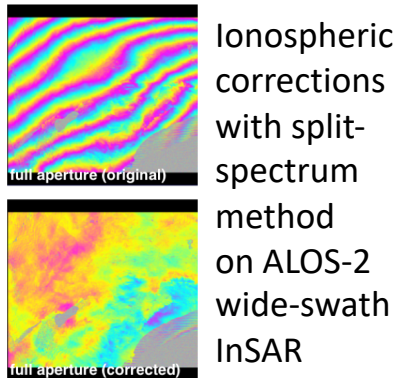

Ionospheric corrections on each scene of time series

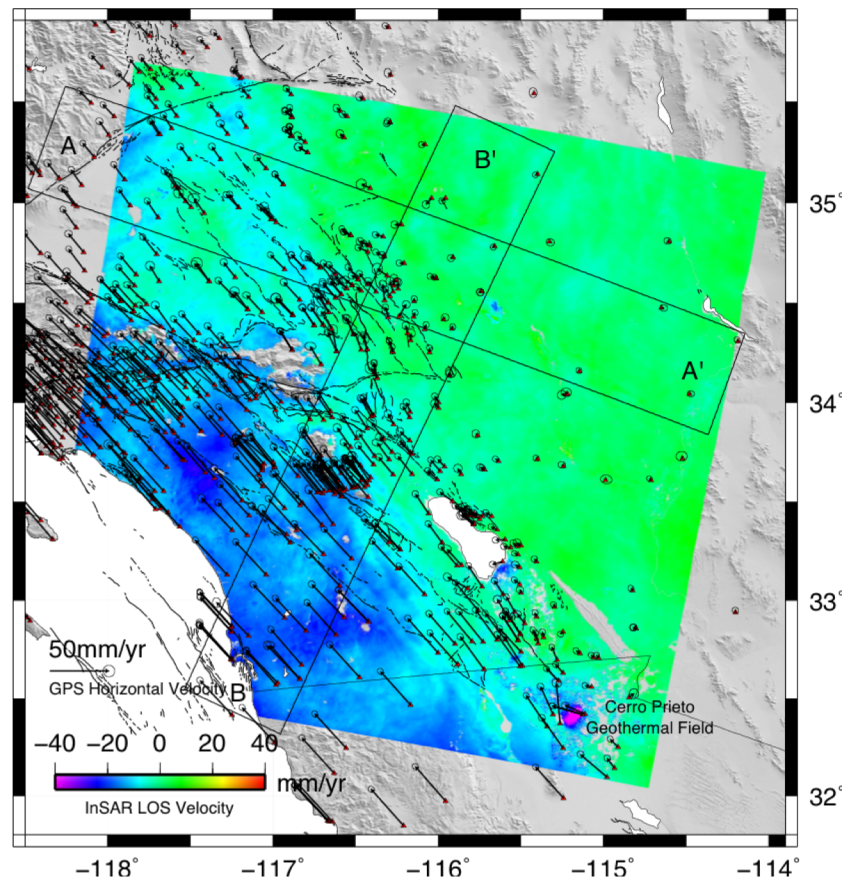
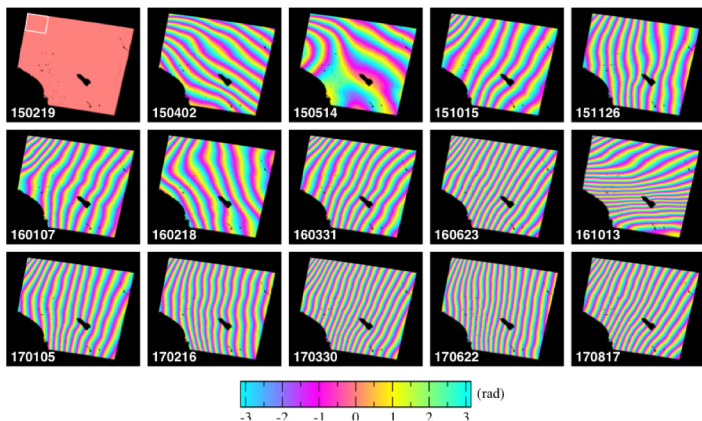

Mean interseismic velocity of Southern California between Feb. 2015 and July 2017

Ionospheric corrections enable measurement of large-scale ground deformation with L-band InSAR without using outside calibration

Liang, C., Z. Liu, E. J. Fielding, and R. Burgmann (2018), InSAR Time Series Analysis of L-Band Wide-Swath SAR Data Acquired by ALOS-2, *IEEE Transactions on Geoscience and Remote Sensing*, 56(8), 4492-4506, doi:10.1109/tgrs.2018.2821150.

• SweepSAR

- On Transmit, illuminate the entire swath of interest (red beam)
- On Receive, steer the beam in fast time to follow the angle of the echo coming back to maximize the SNR of the signal and reject range ambiguities
- Allows echo to span more than 1 Inter-Pulse Period (IPP)

• Consequences

- 4 echoes can be simultaneously returning to the radar from 4 different angles in 4 different groups of antenna beams
- Each echo needs to be sampled, filtered, beam-formed, further filtered, and compressed
- On-board processing is not reversible – Requires on-board calibration before data is combined to achieve optimum performance

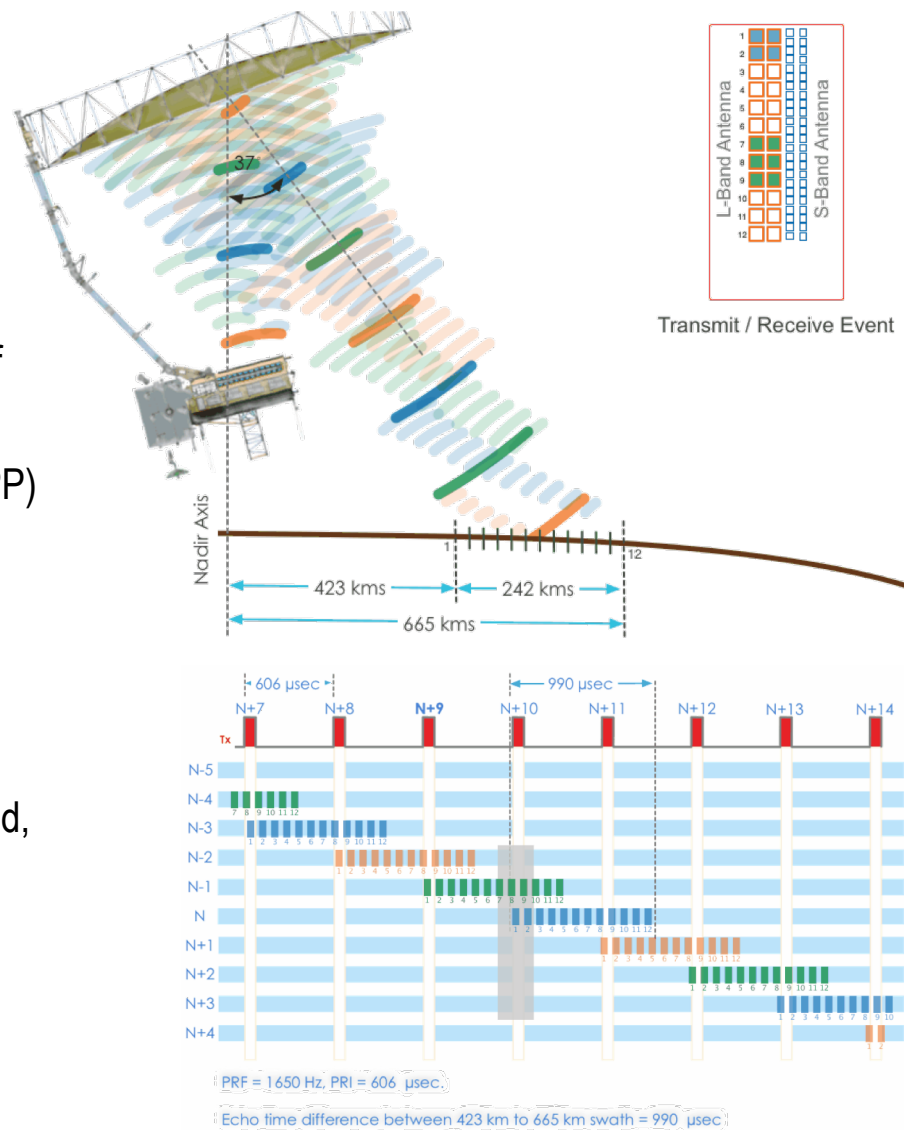

Gaps versus resolution

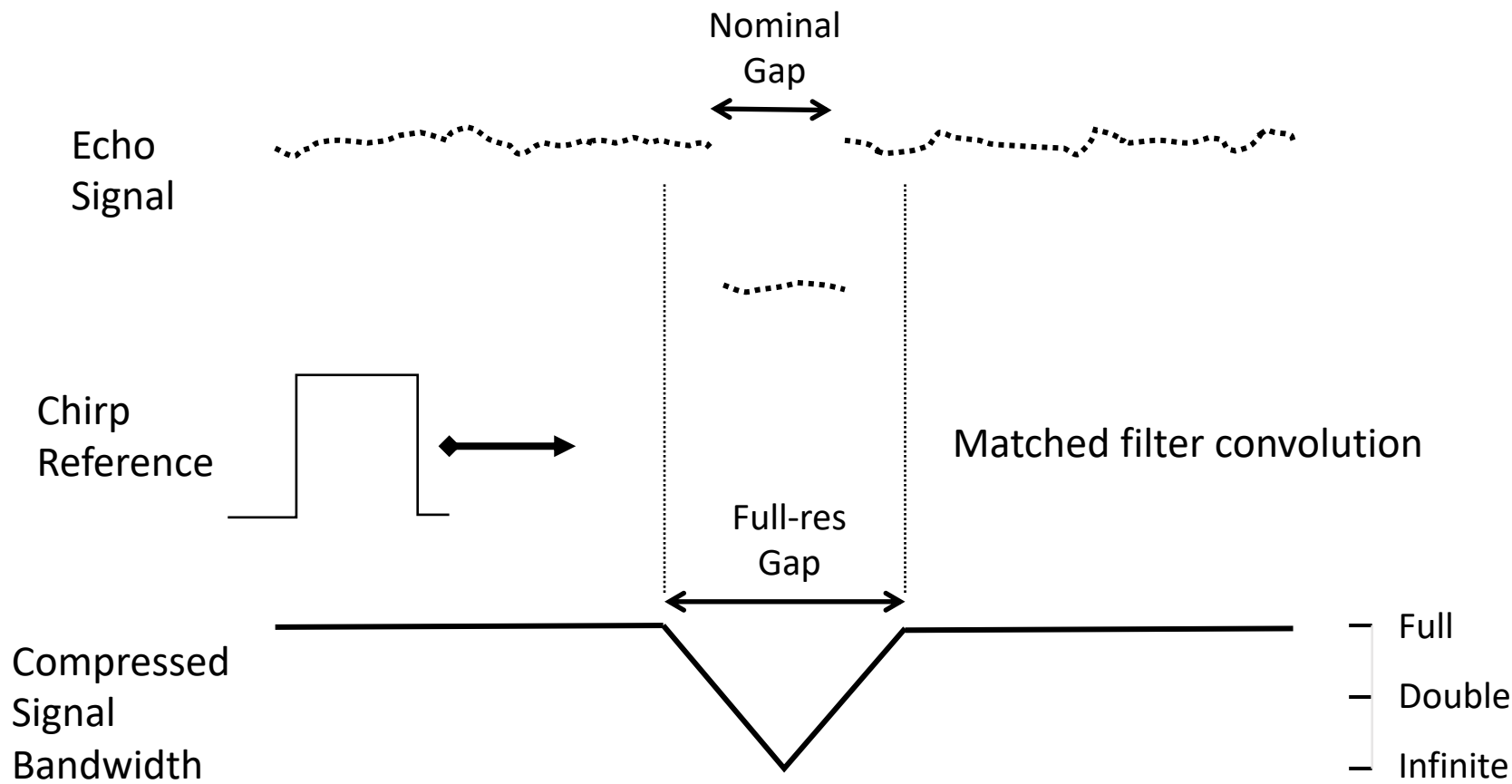

Fixed PRF Operational Characteristics

- NISAR has a fixed set of pulse durations: 5, 20, 25, 40, 45 usecs

Pulse duration (usec)	Gap width in range (km)	Gap width in ground range (near-far) (km)	Gap in Full-res. Obs. (near-far) (km)	Total loss to full-res swath (DP / QP) (km)
5	0.75	1.1-1.4	2.2-2.8	2.2-5.6 / 6.6-11.2
25	3.75	5.6-6.8	11.2-13.6	11.2-27.2 / 33.6-54.4
45	6.75	10.1-12.2	20.2-24.4	20.2-48.8 / 60.6-97.6

DP – Dual Pol (Single-pol or split-band dual-pol transmit; dual-pol receive)

QP – Quad Pol (H and V transmit on alternate pulses; dual-pol receive)

Allows full resolution data only

Assumes

- Fixed PRF
- Background mode
 - 20+5 MHz Dual Pol
 - 2 gaps in swath, each 13.6 km

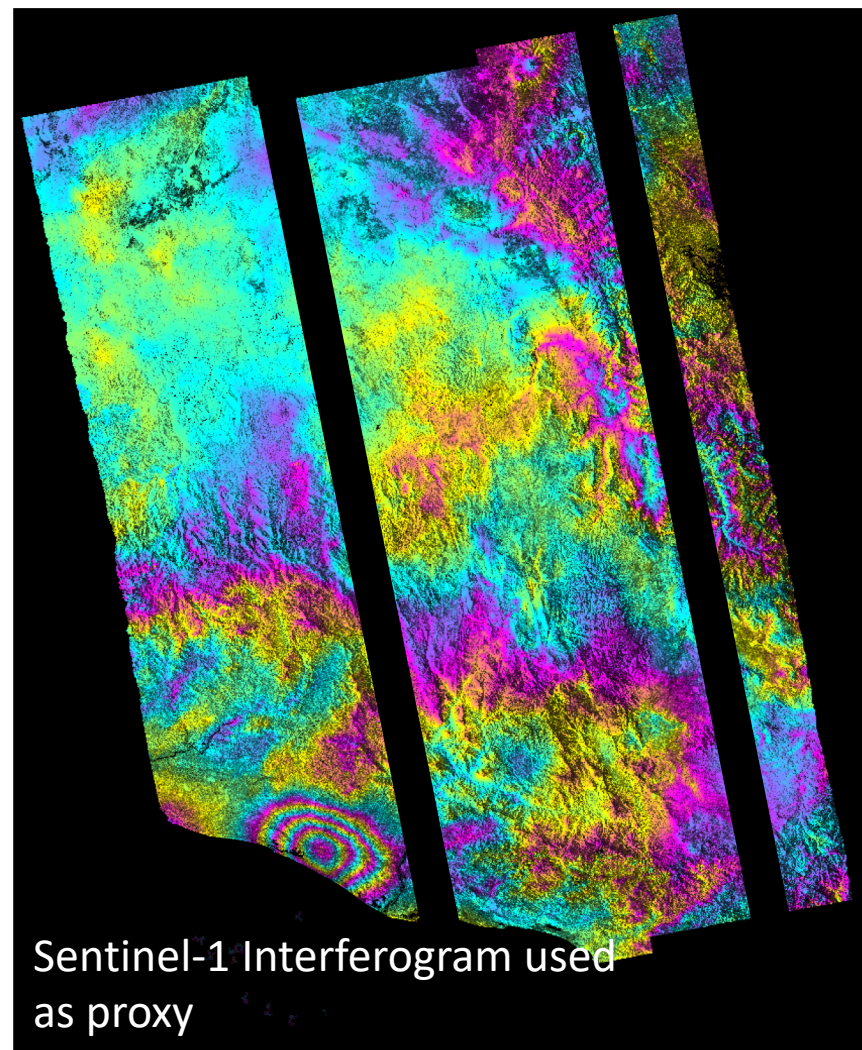

Allows partial resolution data

Assumes

- Fixed PRF
- Background mode
 - 20+5 MHz Dual Pol
 - 2 gaps in swath, each 13.6 km
- ***Use data down to 5 MHz equivalent resolution in gaps***

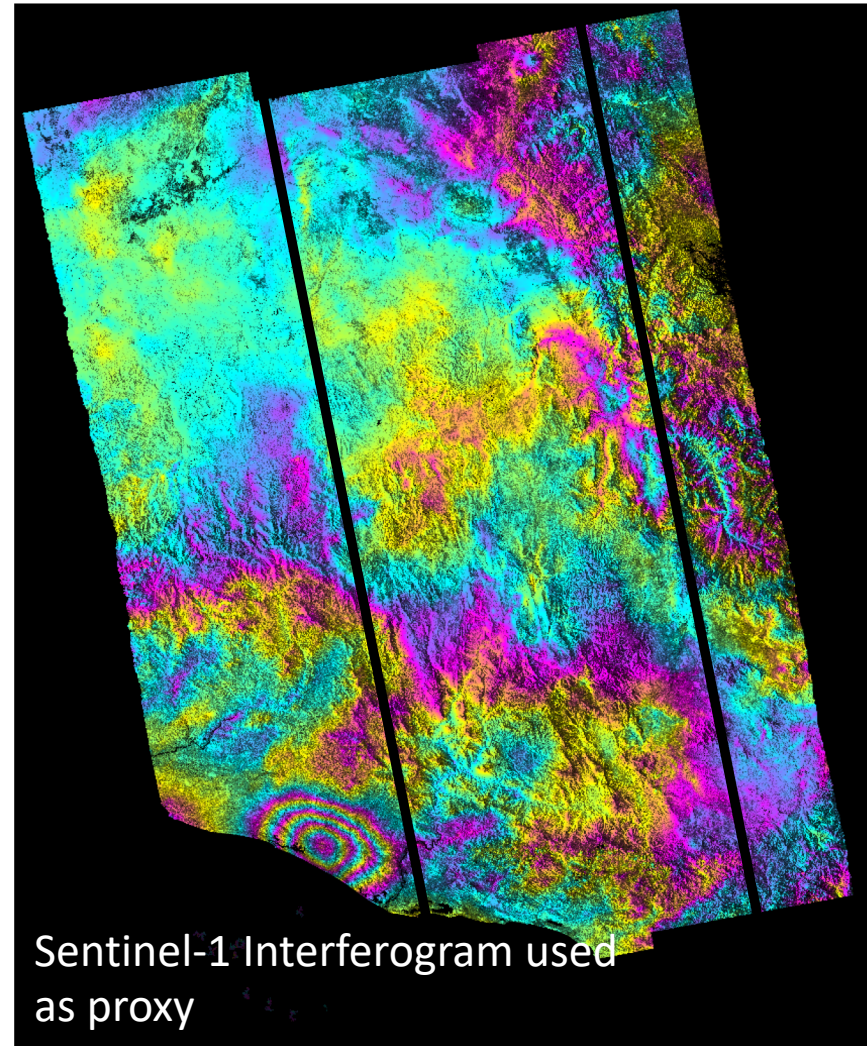

- NISAR science requirements imply dense temporal sampling
- Use of Quad-pol mode coarsens effective temporal sampling by 50-100% depending on the mode used

Bandwidth (resolution)	Pulse length (noise level)	Pulsing scheme (gaps or not)	Swath loss	Ambiguities
40 MHz / 7 m x 7 m	40 usec / -25 dB NESO	Fixed / gaps	~ 50%	Acceptable
40 MHz / 7 m x 7 m	20 usec / -22 dB NESO	Fixed / gaps	~ 25%	Acceptable
20 MHz / 15 m x 7 m	20 usec / -25 dB NESO	Fixed / gaps	~ 20%	Acceptable
Any above	Any above	Variable	Continuous swath	Unacceptable

- For Dual-pol modes, gaps are roughly a factor of 2 fewer for a given pulse width, and pulse rate is lower, so continuous swaths are possible

- In Standard Quad-Pol mode, H and V signals are transmitted alternately using the same frequency band. For NISAR – only fixed PRF operations possible.
- In Quasi quad-Pol mode, H and V signals are transmitted simultaneously in different frequency ranges. Pulse rate is half of QP, improving ambiguities. For NISAR – *continuous swath is possible*.
- For NISAR, upper frequency band is planned to be only around 50 m range res.

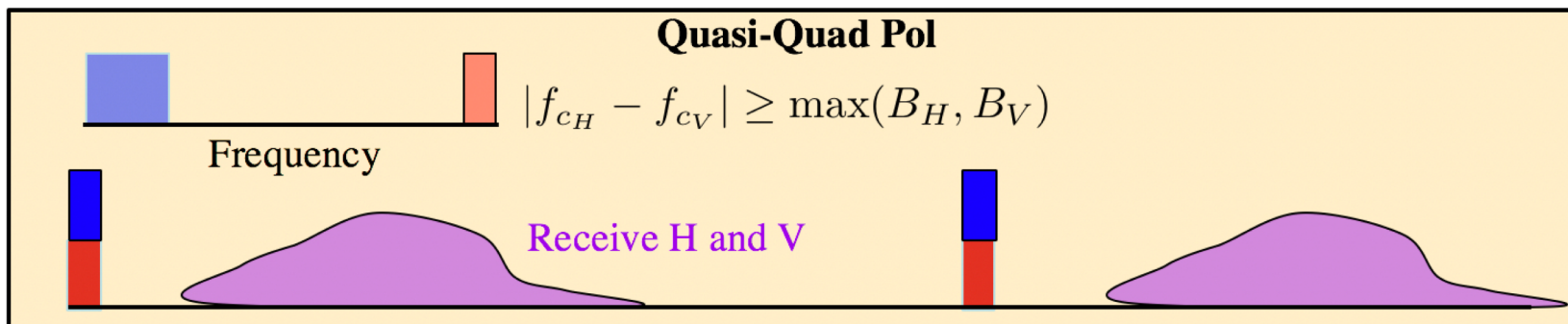
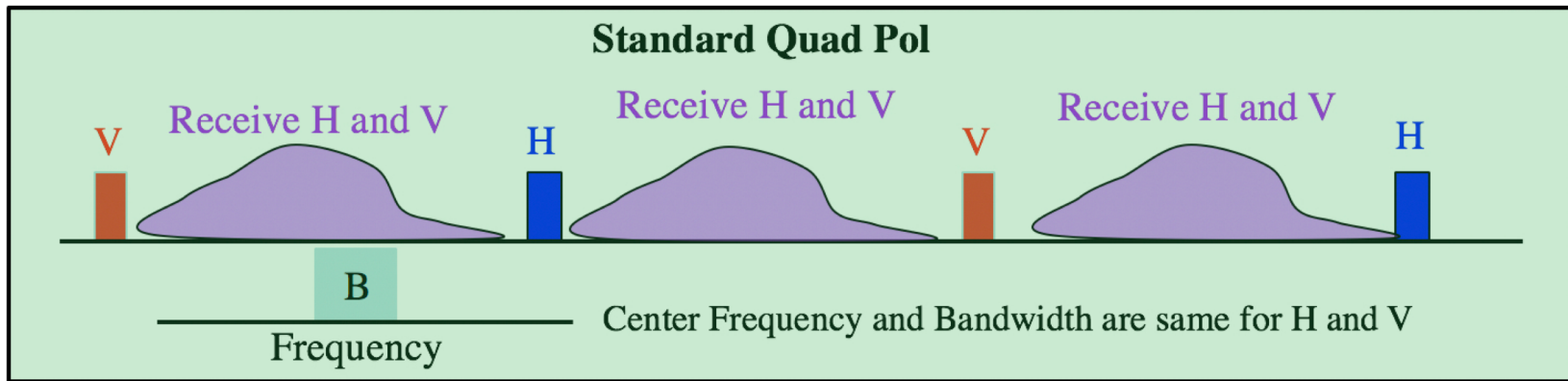

- The main limitations of Quasi Quad-Pol as implemented for NISAR are:
 - VV polarization is only 50 m x 7 m resolution; should be OK for modest resolution applications
 - No HHVV* and associated phase since frequency bands are disjoint (except for point targets)
 - There is new evidence that the polarimetric differences in ground scattering are large enough to add unacceptable noise to the main use of the separated frequency band – ionospheric correction
 - Science Team favors only dual-pol operation to maximize improvement of ionosphere
 - NISAR flying at solar max
 - Ionosphere is a large error source
 - Band was designed for this use
 - Project continues to study impacts to science
- Does the SNWG community have interest in Quasi-quad pol mode as described?

Disciplines	Option 1	Option 2	Rationale
Ecosystems	Quad Pol sparser in time	Dual Pol denser in time	Sampling important due to environmental variability. QP performance marginal.
Ecosystems	Dual-Pol Linear	Dual-Pol Compact	Heritage algorithms
Ecosystems/ Solid Earth	Dual-Pol 40 MHz	Single-Pol 80 MHz	Resolution improvement in range less useful than HV/VH
All	Right 25 cycles and Left 5 cycles	Left Looking Only	Continuity of time series Sentinel-1 for Arctic Better power/thermal
All	Range/Doppler SLC	Geocoded SLC	Passionate arguments on both sides. May be decided by users
All	Full global processing	Processing on demand	NASA requirements
All	Fixed PRF	Variable PRF	Some want gap-free swaths Others want performance

- NISAR is science driven to address key questions in solid earth, ecosystems, and cryospheric sciences
- To address the requirements, NISAR exhibits
 - Consistent global imaging over the life of the mission
 - Polarimetric, interferometric modes
 - Ionospheric correction band
 - Dual frequency L and S-band primarily over India
- Project would like to capture SNWG actual use-case scenarios to complete trade studies
 - How important is quad pol?
 - How important is resolution and temporal sampling?
 - If NISAR can't provide optimal SNWG modes, are there fall-back modes of interest?

